

CAROL

Audrey Sumner.

NEWS

VOLUME 3

ISSUE 23

BOX 1813

LABRADOR CITY MARCH 28th 1968

AUTHORIZED AS SECOND CLASS MAIL BY THE POST OFFICE DEPARTMENT, OTTAWA, AND FOR PAYMENT OF POSTAGE IN CASH

WABUSH WINTER CARNIVAL - 1968

Labrador City Winter Carnival has come and gone and from every aspect proved to be a great success.

Our sister town, Wabush, is at present holding its own Carnival celebrations and we sincerely hope it will have the same success that we enjoyed.

Don't forget, people of Wabush and visitors from Labrador City, that the success of the carnival depends so much on public participation. All the planning and organisation of events etc, need the interest and participation of you, the general public to bring any measure of success at all.

In your programme there are events to suit almost everyone's taste, be it outdoors or indoors, participant or spectator, whatever your part, BE THERE, take the family, enjoy your 'Karnival', after all, that's what it's for.

We are pleased to publish for your convenience the remainder of the Wabush Kin Karnival events:-

THURSDAY, MARCH 28th

7:00 pm:	Ladies Bowling	Recreation Centre
6:30 pm:	Giant Casino	Recreation Centre
9:00 pm:	Bingo	Recreation Centre

FRIDAY, MARCH 29th

8:30 pm:	Teen Dance	
	Masquerade Ball	Recreation Centre
	(Admission \$1.00)	

SATURDAY, MARCH 30th.

11:00 am	Junior Bowling	Recreation Centre
2:30 pm	Bake Sale	Shopping Centre
	Judging ice sculptures (as advertised)	
9:00 pm	Hard Times Dance (as advertised) \$3.00 per couple	Recreation Centre



COME TO CHURCH

ON
SUNDAY MARCH 31st.

PENTECOSTAL CHURCH - GLAD TIDINGS
TABERNACLE. Pastor D.H.Hartwell.

11:00 am Morning Worship
3:00 pm Sunday School
7:30 pm Evangelistic Service

MIDWEEK GROUPS:

THURSDAY (TONIGHT MARCH 28th) YOUNG
PEOPLES SERVICE 8:00 pm:
MONDAY: WOMENS MISSIONARY COUNCIL 8:00pm
TUESDAY: PRAYER SERVICE 8:00pm

ST. PAULS ANGLICAN CHURCH
Rev. L. Whitten.

THURSDAY (TONIGHT MARCH 28th) Junior
Choir Practice 6:30 pm:
A MEETING OF THE BROTHERHOOD OF
ANGLICAN CHURCHMEN WILL TAKE PLACE AT
8:00 pm:

SUNDAY MARCH 31st:

9:45 am Sunday School
11:00 am Morning Prayer
7:00 pm Evening Prayer

ST. PETERS ANGLICAN CHURCH - WABUSH
Rev. L. Whitten
THERE WILL NOT BE AN EVENING SERVICE
THIS COMING FRIDAY AT WABUSH.

SUNDAY MARCH 31st.

11:00 am Morning Prayer
The Sunday School will attend this
service:

WEDNESDAY APRIL 3rd:
Evening Prayer 7:30 pm:

OUR LADY OF PERPETUAL HELP -
Rev. J. Desmarais - Rev. F. Lemire
9:00 am Mass
11:00 am Mass
5:00 pm Mass (French)
7:00 pm Mass

WEEKDAYS: 5:15 pm Mass

OUR LADY OF THE ASSUMPTION - WABUSH
Rev. J. Bergeron.

10:00 am Mass
7:00 pm Mass

WEEKDAYS: 5:00 pm Mass (excepting on
FRIDAYS when Mass will be celebrated
at 3:30 pm:

CAROL UNITED CHURCH
Rev. E. Snider.

9:30 am Sunday School for Junior
9 - 11 years and Inter-
mediates 12 - 15 years.
11:00 am Morning Worship
(Nursery and Kindergarten
5 yrs and under - Cradle
Roll 2 yrs and under.)
2:30 pm Primary Sunday School 6-8 yrs
7:15 pm Song Service
7:30 pm Evening Service.

MIDWEEK GROUPS: As usual.

SALVATION ARMY CITADEL
Captain J. Carew.

11:00 am Holiness Meeting
2:30 pm Sunday School
7:30 pm Evangelistic Meeting.

WEDNESDAY APRIL 3rd: Band Practice -
8:15 pm:

CHRIST CHURCH - WABUSH
(SERVICES - UPSTAIRS IN RECREATION CENTRE)
Rev. Blake Walker

SUNDAY MARCH 31st:

9:45 am Sunday School
11:00 am Morning Worship
7:00 pm Evening Worship

4:30 pm Senior Teens
(30, Bond Ave)

WEDNESDAY APRIL 3rd:
Midweek Meeting - 30 Bond Avenue.

BUILDING PROJECT:
AFTER SUPPER - TUESDAY, WEDNESDAY AND
THURSDAY
DURING THE DAY ON SATURDAY:

GOD GRANT ME THE SERENITY
TO ACCEPT THE THINGS I CANNOT CHANGE;
THE COURAGE TO CHANGE THE THINGS I CAN,
AND THE WISDOM TO KNOW THE DIFFERENCE.

COMING - EVENTS

- POLAR TOPS: will meet as usual on MONDAY evening beginning at 8:00 pm:
- GAMES NIGHT: The regular night of games will be held in the Roman Catholic Church basement this coming MONDAY evening April 1st. beginning at 8:30 pm:
- SOCIAL EVENING IN WABUSH : A social evening will take place on WEDNESDAY, April 3rd. beginning at 8:00 pm: in the Roman Catholic Church hall in Wabush.
- TRAPSHOOTING: takes place every SUNDAY at 1:00 pm: at the Skeet Club.
- SMOKEY MOUNTAIN SKI LODGE: FRIDAY NIGHT DANCE CANCELLED:
- L.A. BRIDGE & AUCTION: There will be an evening of BRIDGE & AUCTION organised by the Local Association of Guides and Brownies on APRIL 18th. in the Labrador City Collegiate Gymnasium. All card enthusiasts are urged to keep this date open and support their local Guides and Brownies by attending this function. Raffle tickets are now being sold by the Local Association on an original oil painting by Mr. W.W. Archer of Labrador City.
- CAROL LADIES COMMUNITY CLUB: The regular monthly meeting of the Carol Ladies Community will take place on THURSDAY APRIL 4th in the All Purpose room of the Labrador City Collegiate beginning at 8:30 pm: MRS ANNE PRESTON will be giving a Tupperware demonstration and tea and coffee will be served. Don't forget your cup ! ! !

ASHUANIPI SOCIAL CLUB SCHEDULE:

```

^ THURSDAY MARCH 28th:
^ FRIDAY MARCH 29th:
^ SATURDAY MARCH 30th:
^ SUNDAY MARCH 31st:
} THE "STAMPEDERS"
  POP GROUP
  FROM CALGARY
^
^
^ TUESDAY APRIL 2nd. Movie Night at 9:00 pm. presents -
^ ' NEVER SAY GOODBYE ' starring Rock Hudson and
^ George Sanders.
^
^ THURSDAY APRIL 4th. Movie Night at 9:00 pm. presents -
^ 'GOODBYE CHARLIE' with Tony Curtis & Debbie Reynolds.
^

```

PRESS RELEASE

NEWFOUNDLAND LAWN TENNIS ASSOCIATION:

The N.L.T.A. is pleased to announce that there are two young Newfoundlanders who have achieved National Junior Tennis Ranking. In the C.L.T.A. ratings, which were recently released, Miss June Saunders was ranked 6th in the under 16 girls age division. Miss Saunders is currently in training for the 1968 season and has one more year left in the under 16 age division. She has an excellent chance this year for either a National Championship or a higher ranking in her category.

John Crowley was listed as Number 8 in the under 12 boys age division. John will be entering the under 14 age classification this year and should make his mark in this division as well.

The N.L.T.A. will be holding an eight week tennis course at the Torbay Recreation Centre beginning April 6 and ending May 25. This course will be designed for any person interested in learning how to play the game of tennis. Applicants for the course must be 16 years of age or over as of January 1, 1968. The instructors for the course will be Mr. Jim Saunders and Mr. Wm. Redden, two prominent local tennis instructors. The cost of the course will be \$5.00 for the eight weeks - there will be one lesson per week, of one and one-half hours duration. The course will be given on Saturday and/ or Monday evenings depending on the demand. Interested people should phone 726-1420 after 4:00 pm: in order to register for the course.

L O S T: ON WEDNESDAY MARCH 27th - 1 ' HEAD ' SKI. FINDER PLEASE CALL 944-2462

X-WORD PUZZLE

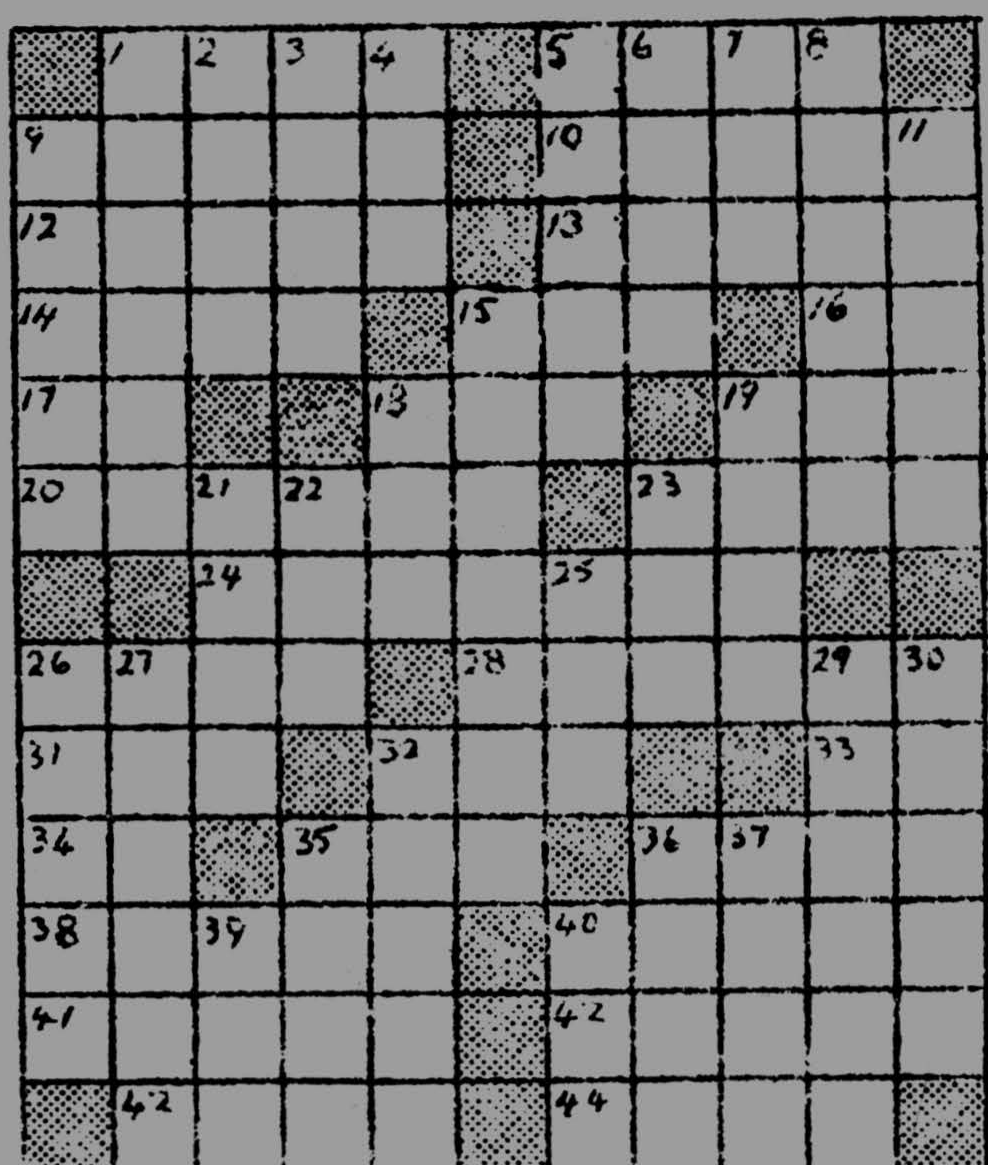

ANSWERS TO MARCH 21st X-WORD

ACROSS			DOWN
1. Soar	26. Late	1. Smear	22. Dope
5. Slap	28. Rapids	2. Opal	23. Ani
9. Ample	31. Ox	3. Alms	25. Ray
10. Cigar	32. Cay	4. Res	26. Loams
12. Reams	33. Eh	5. Scrog	27. Axseed
13. Raise	34. Astral	6. Liar	29. Demure
14. Gals	37. Alme	7. Agio	42. Ascended
15. Morose	39. Meres	8. Passes	43. Belonging to us
16. Ur	40. Aloud	9. Argus	44. Copied.
17. Dig	41. Seine	11. Reels	35. Trio
18. El	42. Roars	15. Mineral	36. Rent
19. Sylvan	43. Dots	17. Bal	37. Aloe
22. Dass	44. Cede	20. Lat	38. Load
24. Aileron		21. Vie	40. Arc

X-WORD FOR MARCH 28th

ACROSS	DOWN
1. Musical sign	1. Excursion
5. Dock	2. Grease
9. Hoisting device	3. Adam's grandson
10. Grew white	4. Bog
12. One of the Great Lakes	5. Ghost
13. Tanker	6. Den
14. Assists	7. Sick
15. Pro	8. Lapwing
16. Burmese native	9. Rocker
17. Part of "to be"	11. Hauls
18. Noah's shelter	15. Cargo
19. Girl's nickname	18. Alas
20. Redo a building's facade	19. Perfume
23. Club obligations	21. Vendetta
24. Sea urchin	22. First-rate
26. Fever	23. Demand, as payment
28. Tree, native to China	25. Aegean island
31. Youth	26. Hawaiian greeting
32. Exclamation	27. Projecting balcony
33. Sun god	29. Rasped
34. Weight: abbr.	30. Farinaceous
35. Calendar abbreviation	32. Malt kilns
36. Thrash	35. Prod
38. See 14 across	36. Reaction on a radar screen
40. Buoy	37. Comfort
41. Around	39. Boy's nickname
42. Ascended	40. Epoch.

(ANSWERS IN NEXT WEEK'S CAROL NEWS)



YOUR PHONE IS
THE WAY TO AN
EASY WASHDAY

CALL OUR NUMBER AND
YOUR LAUNDRY WILL BE
PICKED UP ATTENDED TO
AND DELIVERED BACK TO
YOU PROMPTLY AND
EFFICIENTLY

PHONE 944-2226 OR 944-5323

CAROL LAUNDRY DRYCLEANING

SAVE MONEY AT
WOOLWORTHS

CHILDRENS WINTER
CLOTHING

1/2 PRICE

A LARGE SELECTION
OF MENS & BOYS
SPORTS SHIRTS

1/2 PRICE

JUST ARRIVED !!!

LADIES SHELLS
NEW SPRING
SHADES

\$3-99 - \$4-99

BABIES WOODEN
HIGH CHAIRS

\$17-88

BABY CARRIAGES
CONVERTIBLE TO
STROLLERS

\$46-95 - 64-95



EASTER CANDY

EVER POPULAR
"NAME" EGG
NAME WRITTEN 69c
FREE

STANDING HOLLOW
BUNNY
6oz \$1-27

COWBOY HATS
TOPPED WITH EASTER
CANDY
\$1-29

CHOCOLATE FOIL
EGGS
1 lb PACKAGE 99c

EASTER BASKETS FILLED
WITH EGGS

\$1-19 - 1-39

WOOLWORTHS

FOR SALE

Chesterfield and two chairs

Stereo Heathkit Amplifier - 30 watts.
Hallicrafter receiver, model SX.110.
general coverage, 5 hambands.

Household furniture for sale

Four maternity dresses

R.C.A. Victor Record Player in very good condition

Thistle baby carriage, Babies car bed. Large crib.
(All in excellent condition)

1965 Ford Fairlane, automatic, 6 cylinder.

PLEASE RING

944 - 5290 after 5:00 pm:

944 - 2711

944 - 2412

944 - 5618

944 - 2933

944 - 5137

944 - 2257

WANTED TO BUY

High boy or something suitable for child's room.

944 - 5765

Large baby crib in good condition.

944 - 5618

Convertible baby carriage

944 - 5572

ACCOMODATION REQUIRED:

Couple require house, apartment or trailer to rent

944 - 5653

Couple without children require apartment, house or)
trailer.)

944 - 2606 during day
944 - 2295 evenings

HELP WANTED:

Woman to help in housekeeping on Mondays. Will pay
\$8.00 per day,

944 - 2377 after 6:00 pm:

LOST:

A pair of girls prescription glasses with pink frames
lost between McManus School and Curtis Crescent.

944 - 2064

- SIMPLE RECIPES TO CUT OUT AND KEEP -

INGREDIENTS:

8 oz. flour
8 oz. butter or margarine
Iced water
Apple pulp
Cream
Glacé icing
Chopped almonds
Glacé cherries and
angelica.

SWEDISH THOUSAND LEAVES TORTE

METHOD:

Sieve the flour and cut in the fat, using a knife.
Use iced water to mix, and work the mixture with
a wooden spoon until it is smooth; cover and
chill. Divide into 6 - 7 portions, roll very
thinly on waxed paper, cut into rounds and prick
all over. Put on to a baking tin, brush over
with iced water and bake in a hot oven (450°F.,)
for 6 - 8 minutes. Keep on the waxed paper until
cold. Spread alternate pastry rounds with apple
pulp and cream, building them up like a layer
cake. Top with icing and decorate with a ring
of browned almonds, and with glacé cherries and
angelica.

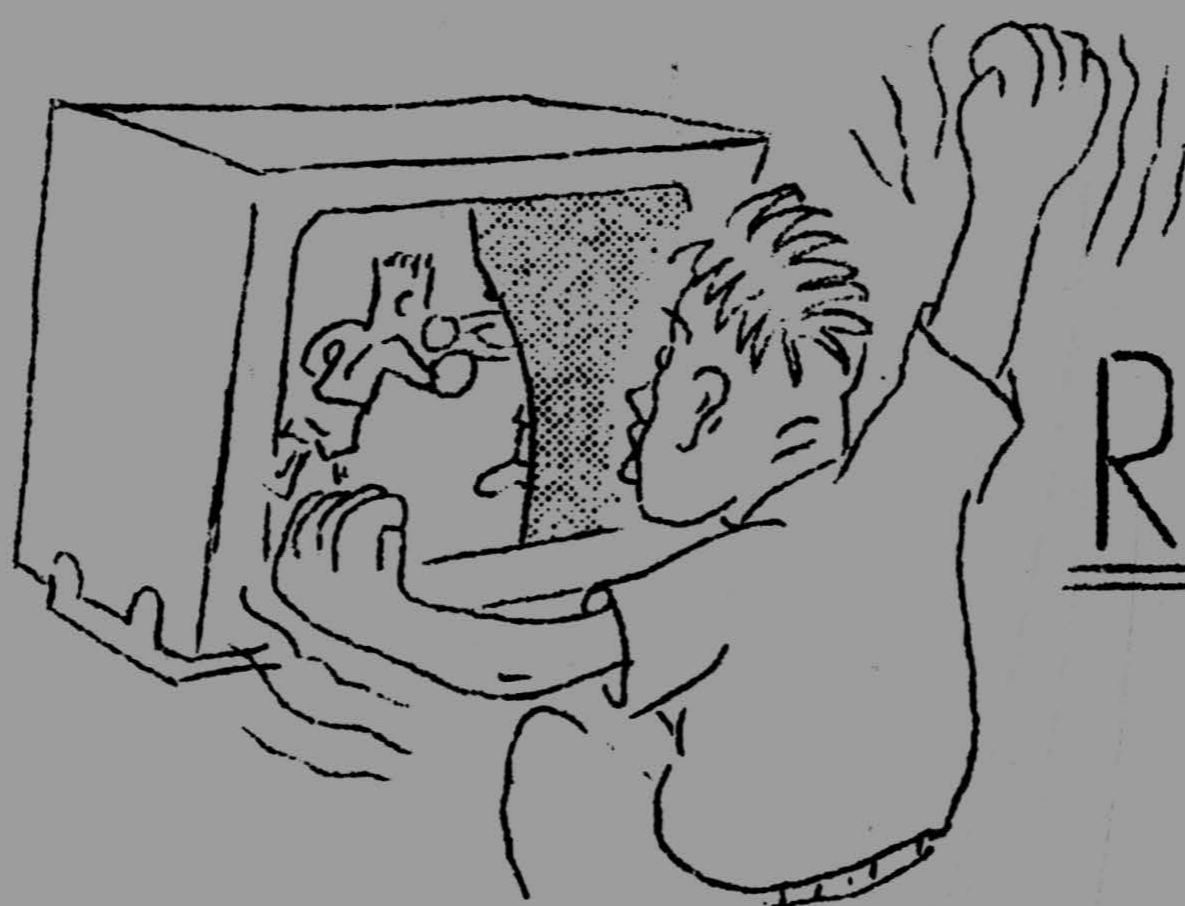

TV
REPAIR

RECORD PLAYERS

STERIOS

TAPE RECORDERS

RADIOS HI-FI

etc:

~~~~~  
^ SERVICE: DAY & NIGHT ^  
^ WITH ALL WORK GUARANTEED ^  
^~~~~~

# ELECTROLUX

(CANADA) LTD

THE WORLD'S MOST IMITATED  
CLEANER AND THE WORLD'S ONLY  
FULLY AUTOMATIC CLEANER.....

THE  
ZB 88

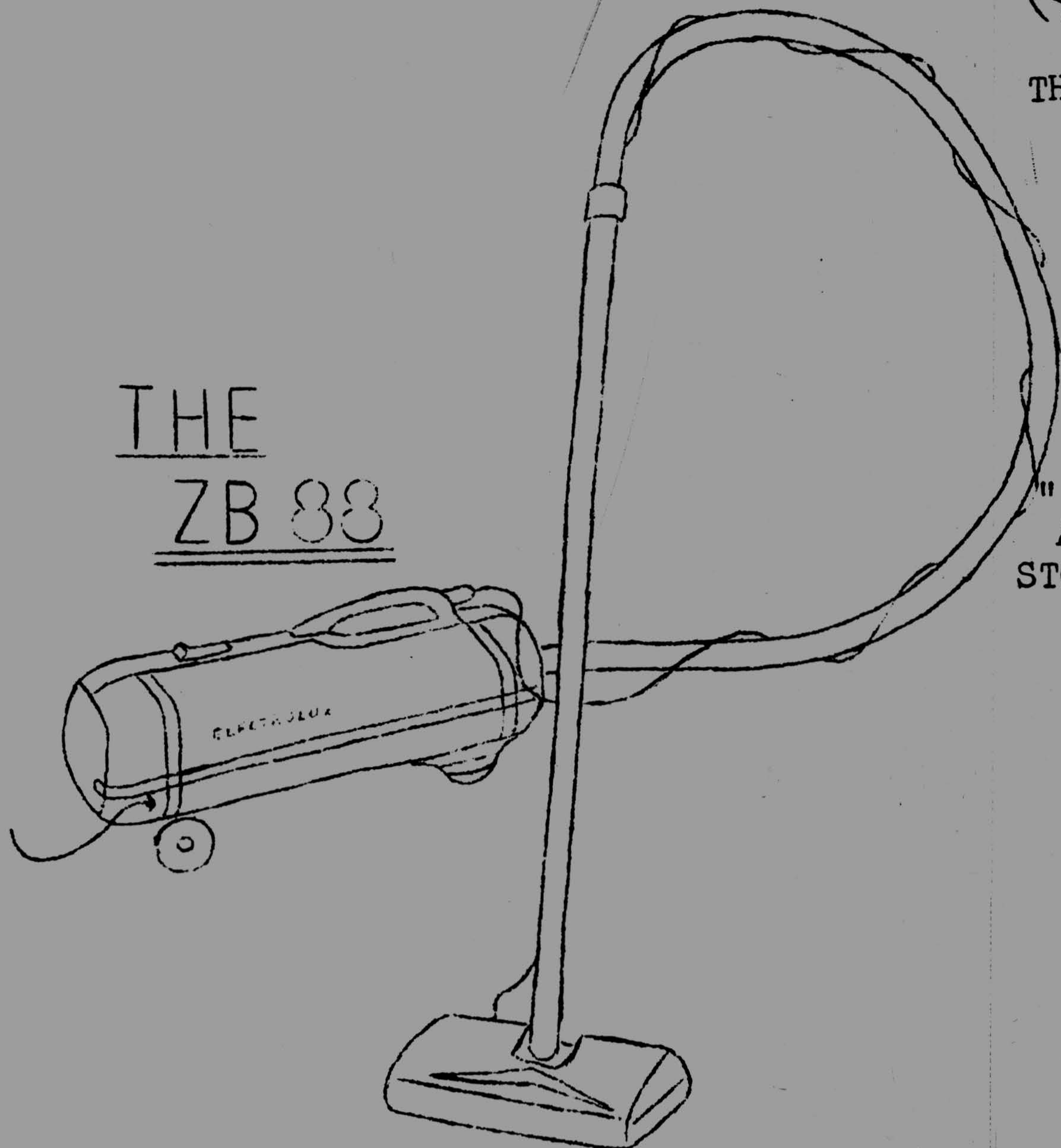

FEATURING THE FAMOUS  
Z B. 88 VACUUM  
CLEANER WITH THE  
" POWER NOZZLE "  
AND AN OPTIONAL  
STOWAWAY CHEST.

ALSO THE LATEST FLOOR AND RUG  
CONDITIONER - THE BX 20 FLOOR  
POLISHER, WHICH SCRUBS YOUR  
FLOORS, SHAMPOOS YOUR RUGS,  
AND POLISHES YOUR FLOOR, ALL  
WITH THE SAME MACHINE.

YOU WOULD HAVE TO SEE THIS  
WONDERFUL MACHINE TO FULLY  
APPRECIATE ITS VALUE.

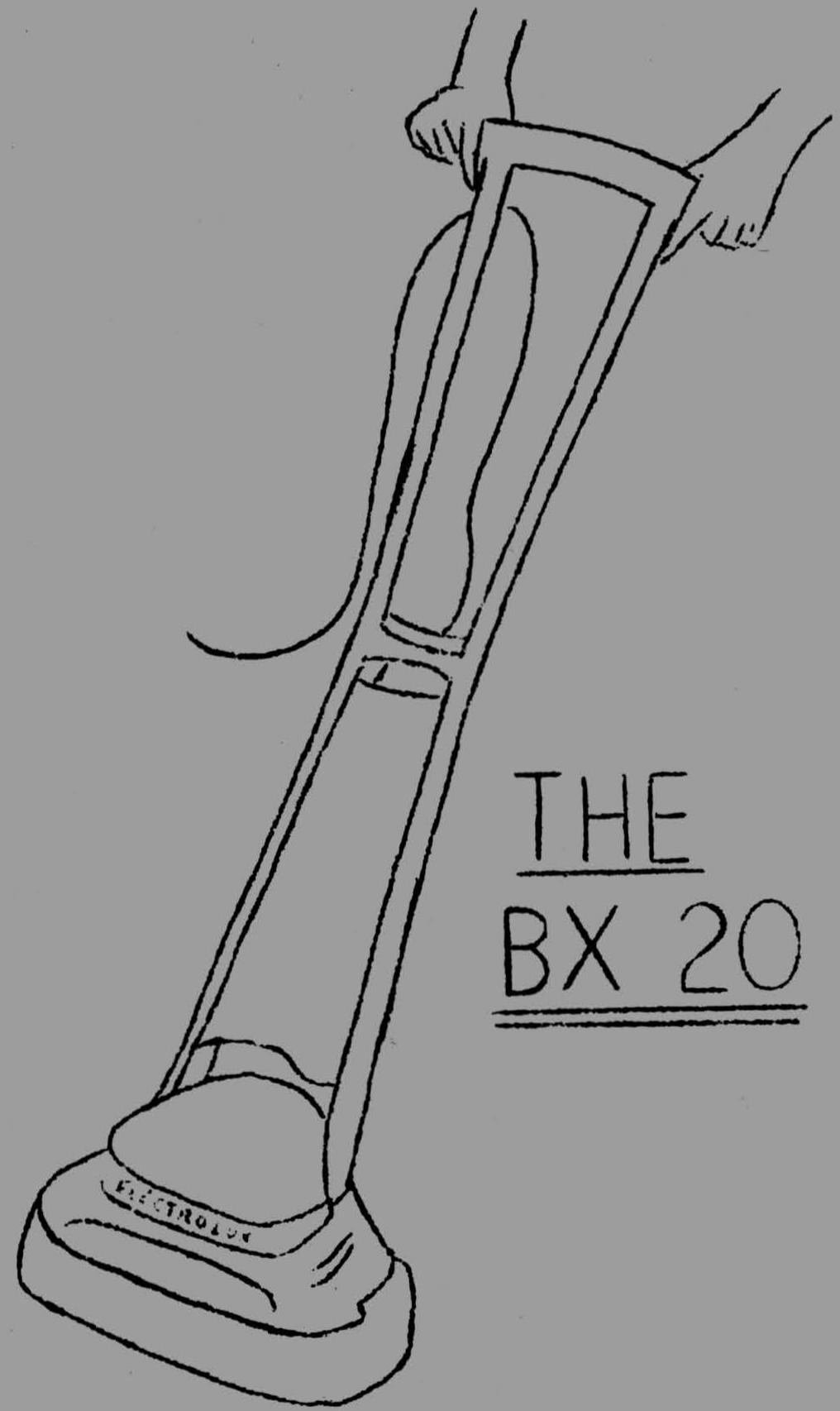

THE  
BX 20

YOUR ELECTROLUX REPRESENTATIVE IN LABRADOR  
CITY WILL BE PLEASED TO GIVE YOU A FREE  
DEMONSTRATION.

WHY NOT GIVE ME A CALL, AND TAKE ADVANTAGE  
OF OUR VERY EASY TERMS???

WE HAVE IMMEDIATE DELIVERY, AND STOCK EVERY-  
THING FOR YOUR FUTURE NEEDS.

FOR MORE INFORMATION - PLEASE CALL:..... 944 - 2215 or 944 - 2361

A FULL 2-YEAR GUARANTEE ON

ALL OUR PRODUCTS

ELECTROLUX REPRESENTATIVE  
FOR LABRADOR CITY & WAPUSH

LEN LEYTE

- SMOKEY MOUNTAIN SKI CLUB -

Our Annual Invitational Ski Meet will be held on MARCH 30th and 31st. We expect skiers from Schefferville, Gagnon, Gallix (Sept-Iles and Port Cartier), Goose Bay, Corner Brook and St. John's competing with our top-notch skiers.

COME AND SUPPORT YOUR CLUB

- SCHEDULE -

| <u>SATURDAY, MARCH 30, 1968</u> |                                       | <u>SUNDAY, MARCH 31, 1968</u> |                                            |
|---------------------------------|---------------------------------------|-------------------------------|--------------------------------------------|
| 10:30 am                        | Junior B,C,D, & E Registration closes | 9:30 am                       | Registration closes for Seniors & Junior A |
| 10:40 am                        | Racing numbers available              | 9:40 am                       | Racing numbers available                   |
| 11:00 am                        | Junior B.C.D, & E Giant Slalom        | 10:00 am                      | Seniors & Junior A Slalom                  |
| 1:30 pm                         | Junior B,C, & D Slalom                | 1:00 pm                       | Seniors & Junior A Giant Slalom            |
| 3:00 pm                         | Senior & Junior A Registration closes | 3:30 pm                       | Old Timers Race                            |
| 3:30 pm                         | Senior & Junior A,B & C Downhill      | 3:30 pm                       | Obstacle Race                              |
| 6:00 pm                         | Supper at the Lodge                   | 5:00 pm                       | Presentation of Trophies                   |
| 7:00 pm                         | Night Skiing                          | 6:00 pm                       | Steak Roast                                |
| 8:30 pm                         | Torch Light Parade                    |                               |                                            |
| 9:00 pm                         | Dance                                 |                               |                                            |

PLEASE NOTE::: THE DANCE WHICH WAS TO BE HELD AT THE SKI LODGE THIS COMING FRIDAY, HAS NOW BEEN CANCELLED

Royal Canadian Legion  
Newfoundland & Labrador Command  
156, Water St; ST. JOHN'S, NFLD:

- NEWS RELEASE -

Fred V. Williams, Provincial President, Royal Canadian Legion, announces with pleasure that the Centennial Medal has been awarded to the following Legion members:-

W.R. Dawe, O.B.E., W.R. Martin, Mrs. Edith Avery, James M. Fagan, Fred V. Williams, William C. Janes, H.B. Morgan, QC., LL.B., A.K. Scott, Howard Saunders, Stan Butt, George Scott, Fred Matthews, Ernest D. Cheeseman, Fred Samms, Albert Rollings.

The awards are made in recognition of many years devoted service to the Legion and on behalf of veterans and dependents. Congratulations are extended to all recipients whose service has been so fittingly remembered.

- O R T H O D O N T I S T -

Dr. Brett Williams will be in Labrador City Dental Office on March 29th and 30th. For appointments call DR. OBRAZCOVA at 944 - 5445 between 9:00 am - 12:00 noon and 1:00 pm - 5:00 pm:

NOTE!!!! IF THERE IS A DATE ON  
YOUR ADDRESS LABEL, YOUR \_\_\_\_\_  
SUBSCRIPTION IS DUE. \_\_\_\_\_

PROTECTION OF EVERY DESCRIPTION  
FIRE AUTO SKIDOO MARINE LIFE DISABILITY

RAY HAMMOND

Representative for

TOMLINSONS INSURANCE

THUR. & FRI. "NITELITE" SPECIALS  
7PM - 9PM

LADIES MATERNITY  
TOPS

WIDE SELECTION

Reg \$5-98 - 7-98

NITELITE \$3-99

"SWINGER" CAMERAS

BY POLAROID

Reg \$23-95

NITELITE \$16-88

WHILE THEY LAST

MENS TOPCOATS  
& CARCOATS

VALUES TO \$45-00

NITELITE \$10-00

A LARGE SELECTION  
OF MENS DRESS  
SHIRTS

WHITE STRIPED OR  
CHECKS

14-17

NITELITE \$2-00

BOYS JACKETS

FULL LINING

ZIPPER CLOSING

4-6x Reg \$2-98

NITELITE \$1-77

LADIES SPRING

SUEDE SHOES

& BOOTS

NITELITE \$4-99

A GROUP OF KIDDIES COATS

VALUES TO \$25-00

NOW WHILE THEY LAST \$9-97

FURNITURE SALE

20% SAVINGS ON

SLIGHTLY DAMAGED

CHESTERFIELDS

*Chapman's* LTD

WABUSH

PRESENTATION OF AWARDS TO GUIDES

The regular meeting of the 1st Carol Lake Guide Company took place at the Scout Lodge on Tuesday evening March 19th. under the direction of Captain Jean Fenato.

This was a very special evening for 10 tenderfoot guides who were enrolled by the district commissioner, and welcomed into the sisterhood of guides.

The following guides were presented with badges which they had earned:-

KATHY PLUE - 1st.class badge: Keep Fit Badge:  
Needlewoman's Badge: Little House Emblem:

GAIL MILLER - Hostess Badge

OATHY CUNNINGHAM - Needlewoman's Badge:  
Little House Emblem:

CAROL ROBERTSON - 2nd class badge:

NANCY LAMBERT - 1st class badge: Skater's Badge:  
Handywoman Badge: Citizenship Badge:

The highlight of the simple but impressive ceremony was the presentation of the second highest award guiding offers, to Nancy Lambert - her All Round Cord symbolic of her interest in guiding and much hard work accomplished.

A social hour followed with refreshments supplied by several guides working on their Hostess Badge. This was greatly enjoyed by parents, guiders and guides. The guides were honoured by a visit from Mr. Kevin Green ( The Chief ) and Mr. Alex Hicks (Akela) of the Boy Scouts.

The evening concluded with campfire songs with visitors and parents joining in.

The 1st.Carol Lake Company expresses their thanks to the Scout Committee for the use of their Scout Lodge.

-----  
- NEWS RELEASE FROM THE CANADIAN RED CROSS SOCIETY -

The Premier, the Honorable J.R.Smallwood, who is also the Honorary President of the Nfld:Division of the Canadian Red Cross Society,has endorsed the work of the Society with these words.

" I have been asked to say a few words, endorsing the work of the Canadian Red Cross Society.

In both capacities, I have become very familiar with the great humanitarian work of Red Cross in Newfoundland and throughout the World and I make no apologies for asking you to assist this world-wide organization, particularly at this time in the history of the World, when there is so much suffering and bloodshed. I would ask you to remember then when you contribute to Red Cross, you are not only helping to alleviate the suffering of the victims of war in Viet Nam - both north and south - and, also victims of disasters in other countries, but you are also helping to alleviate the sufferings of many of your fellow Newfoundlanders.

To illustrate this, I would point out that in 1967 over 17,000 Newfoundlanders cared enough to give their blood, so that 4,991 of their fellow countrymen might live. 2,750 patients were accommodated at the Red Cross Hostel - a home away from home.

There are 30,000 of our youth participating in the Red Cross Youth programmes in Newfoundland schools, developing them to be healthier community-minded citizens.

Over 12,000 men,women and children received instructions in Water Safety.

1,055 of our fellow Newfoundlanders were assisted by Red Cross Disaster Committees throughout the Provinces and which cost the Society \$21,540.00.

There are many other programmes and services provided by the Red Cross, such as Women's Work Volunteers, who are the backbone of the Society; the Sickroom Loan Service, Care in the Home Course, Well Baby Clinics, the teaching of Arts and Crafts to our War Veterans.

When you give to Red Cross your money goes to support twelve different services.

This year,1968, we celebrate the twentieth anniversary of the "United Nations Universal Declaration of Human Rights", and what more fitting way do we have to celebrate this event than to contribute as much as possible to Red Cross,whose aims and objects are based on the fundamental right of everyone- the right to life itself - for without this right, we can have no other human or civil rights.

Disaster,sickness and accidents can occur to anyone and without warning. It could happen to you or a member of your family. Help the Red Cross to be on the job by giving generously.

THANK YOU.

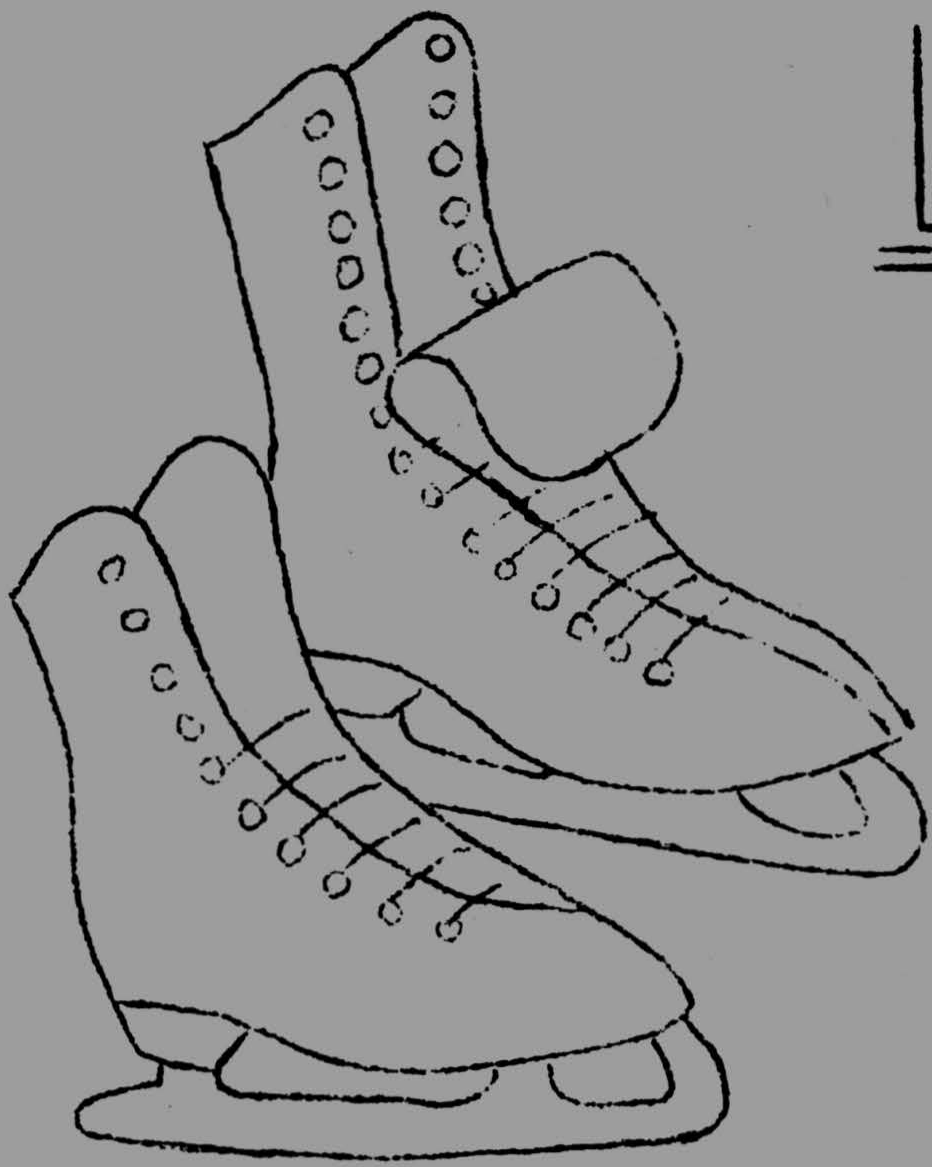

# LABRADOR CITY ARENA

## WEEKLY SCHEDULE

|                      |                                                                                                            |                                                                                                      |
|----------------------|------------------------------------------------------------------------------------------------------------|------------------------------------------------------------------------------------------------------|
| THURSDAY MARCH 28th  | LADIES & TOTS SKATING<br>MINOR HOCKEY<br>BROOMBALL<br>BRAVES vs WABUSH<br>MILL vs LAB.                     | 10:00 am<br>4:45 pm to 6:45 pm<br><br>7:30 pm<br>9:00 pm                                             |
| FRIDAY MARCH 29th.   | CASUAL RENTALS<br>MINOR HOCKEY<br>BRAVES PRACTICE<br>BROOMBALL<br>WABUSH vs ROYALS<br>WAREHOUSE vs ROCKETS | 8:00 am to 4:00 pm<br>4:45 pm to 6:45 pm<br>7:00 pm to 8:00 pm<br><br>7:30 pm<br>9:00 pm             |
| SATURDAY MARCH 30th. | MINOR HOCKEY<br>PUBLIC SKATING<br>FIGURE SKATING<br>PUBLIC SKATING                                         | 8:00 am to 1:00 pm<br>2:00 pm to 4:00 pm<br>4:30 pm to 6:00 pm<br>8:30 pm to 10:30 pm                |
| SUNDAY MARCH 31st.   | CASUAL RENTALS<br>PUBLIC SKATING<br>MINOR HOCKEY<br>BROOMBALL<br>WARLOCKS vs MILL<br>PUBLIC SKATING        | 8:00 am to 1:00 pm<br>2:00 pm to 4:00 pm<br>4:30 pm to 6:30 pm<br><br>7:00 pm<br>8:30 pm to 10:30 pm |
| MONDAY APRIL 1st.    | CASUAL RENTALS<br>MINOR HOCKEY<br>BRAVES PRACTICE<br>PUBLIC SKATING                                        | 8:00 am to 4:00 pm<br>4:45 pm to 6:45 pm<br>7:00 pm to 8:00 pm<br>8:30 pm to 10:30 pm                |
| TUESDAY APRIL 2nd.   | LADIES & TOTS SKATING<br>MINOR HOCKEY<br>BROOMBALL<br>WAREHOUSE vs BRAVES<br>AVENGERS vs LAB.              | 10:00 am<br>4:45 pm to 6:45 pm<br><br>7:30 pm<br>9:00 pm                                             |
| WEDNESDAY APRIL 3rd. | MINOR HOCKEY<br>BRAVES PRACTICE<br>PUBLIC SKATING                                                          | 4:45 pm<br>7:00 pm to 8:00 pm<br>8:30 pm to 10:30 pm.                                                |





- T. V. SCHEDULE -

THURSDAY MARCH 28th

|       |       |                      |
|-------|-------|----------------------|
| 4:00  | 4:30  | The Edge of Night    |
| 4:30  | 5:00  | Bonny Prudden        |
| 5:00  | 5:30  | Take 30              |
| 5:30  | 6:00  | Bobino               |
| 6:00  | 6:30  | La Boite a Surprises |
| 6:30  | 7:00  | Upside Town          |
| 7:00  | 7:30  | Winter Olympics      |
| 7:30  | 8:00  | Charlie Brown        |
| 8:00  | 8:30  | Hogan's Heroes       |
| 8:30  | 9:00  | Telescope            |
| 9:00  | 9:30  | A la Seconde         |
| 9:30  | 10:00 | Camera '68           |
| 10:00 | 10:30 | Don Messer's Jubilee |
| 10:30 | 11:00 | Man at the Centre    |
| 11:00 | 11:10 | C.B.C. News          |
| 11:10 |       | Winter Olympics      |

OMITTED: 3:30 to 4:00: Canadian School Tel

FRIDAY MARCH 29th.

|       |       |                             |
|-------|-------|-----------------------------|
| 4:00  | 4:30  | The Edge of Night           |
| 4:30  | 5:00  | Bonny Prudden               |
| 5:00  | 5:30  | Take 30                     |
| 5:30  | 6:00  | Bobino                      |
| 6:00  | 6:30  | La Boite a Surprises        |
| 6:30  | 7:00  | Upside Town                 |
| 7:00  | 7:30  | Let's Go !                  |
| 7:30  | 8:30  | Perdus dans L'espace        |
| 8:30  | 9:00  | Get Smart                   |
| 9:00  | 9:30  | The Tommy Hunter Show       |
| 9:30  | 10:30 | ' THE BARON '               |
| 10:30 | 11:00 | In Person                   |
| 11:00 |       | C.B.C. News                 |
| 11:10 |       | Late Night Theatre -        |
|       |       | ' GIRL IN BLACK STOCKINGS ' |

with Lex Barker, Anne Bancroft,  
Mamie Van Doren, Ron Randell.

SATURDAY MARCH 30th.

|       |       |                              |
|-------|-------|------------------------------|
| 4:00  | 5:00  | Championship Tennis          |
| 5:00  | 5:30  | Tour de Terre                |
| 5:30  | 6:00  | Bidule Tarmacadam            |
| 6:00  | 7:00  | Moby Dick & Bugs Bunny       |
| 7:00  | 7:30  | The Mark of Zorro            |
| 7:30  | 8:00  | This Land of Ours            |
| 8:00  | 8:30  | The Beverly Hill Billies     |
| 8:30  | 10:30 | N.H.L. Hockey -              |
|       |       | (Detroit at Montreal)        |
| 10:30 | 11:00 | Les Couche Tard              |
| 11:00 | 11:10 | C.B.C. News                  |
| 11:10 |       | Cinema - ' VIRGINITE '       |
|       |       | avec Irene Gemma et Leonardo |
|       |       | Cortese.                     |

PLEASE NOTE:  
THIS SCHEDULE IS SUBJECT TO CHANGE  
WITHOUT NOTICE.

SUNDAY MARCH 31st

|       |       |                         |
|-------|-------|-------------------------|
| 4:00  | 4:30  | Man Alive               |
| 4:30  | 5:00  | Hymn Sing               |
| 5:00  | 5:30  | La Vie Qui Bat          |
| 5:30  | 6:00  | Les Hommes des L'espace |
| 6:00  | 6:30  | Caribou Country         |
| 6:30  | 7:30  | The Ed Sullivan Show    |
| 7:30  | 8:00  | Flashback               |
| 8:00  | 9:00  | Les Beaux Dimanches     |
| 9:00  | 10:00 | Donanza                 |
| 10:00 | 11:00 | The Way It Is           |
| 11:00 |       | Winter Olympics         |

MONDAY APRIL 1st.

|       |       |                        |
|-------|-------|------------------------|
| 4:00  | 4:30  | Music in Miniature     |
| 4:30  | 5:00  | Caribou Country        |
| 5:00  | 5:30  | Luncheon Date          |
| 5:30  | 6:00  | Bobino                 |
| 6:00  | 6:30  | La Boite a Surprises   |
| 6:30  | 7:00  | Australia Today        |
| 7:00  | 7:30  | Winter Olympics        |
| 7:30  | 8:30  | Le Paradise Terrestre  |
| 8:30  | 9:30  | Show of the Week       |
| 9:30  | 10:00 | Front Page Challenge   |
| 10:00 | 11:00 | The Carol Burnett Show |
| 11:00 | 11:10 | C.B.C. News            |
| 11:10 |       | Winter Olympics        |

TUESDAY APRIL 2nd

|       |       |                                |
|-------|-------|--------------------------------|
| 3:30  | 4:00  | Canadian School Telecast       |
| 4:00  | 4:30  | Music in Miniature             |
| 4:30  | 5:00  | Caribou Country                |
| 5:00  | 5:30  | As Time Goes By                |
| 5:30  | 6:00  | Bobino                         |
| 6:00  | 6:30  | La Boite a Surprises           |
| 6:30  | 7:00  | Footprints                     |
| 7:00  | 7:30  | Let's Go !                     |
| 7:30  | 8:30  | Winter Olympics                |
| 8:30  | 9:00  | Rue de Pignons                 |
| 9:00  | 9:30  | A Guichet Ferme                |
| 9:30  | 10:30 | ' WHAT HAPPENED HERE ? '       |
|       |       | special: Candidates of Liberal |
|       |       | Leadership Race.               |
| 10:30 | 11:00 | The Public Eye                 |
| 11:00 |       | C.B.C. News                    |

WEDNESDAY APRIL 3rd:

|       |       |                             |
|-------|-------|-----------------------------|
| 4:00  | 4:30  | Music in Miniature          |
| 4:30  | 5:00  | Caribou Country             |
| 5:00  | 5:30  | As Time Goes By             |
| 5:30  | 6:00  | Bobino                      |
| 6:00  | 6:30  | La Boite a Surprises        |
| 6:30  | 7:00  | Upside Town                 |
| 7:00  | 7:30  | Winter Olympics             |
| 7:30  | 8:00  | D'Iberville                 |
| 8:00  | 8:30  | Moi et L'autre              |
| 8:30  | 9:30  | Mission Impossible          |
| 9:30  | 11:00 | FESTIVAL presents ' THE ART |
|       |       | OF ROSTROPOVICH '           |
| 11:00 | 11:10 | C.B.C. News                 |
| 11:10 |       | Winter Olympics             |



**DOMINION  
STORES**

SHOP AT YOUR FRIENDLY DOMINION STORE  
AND REMEMBER

ARRÊTES A VOTRE MAGASIN DOMINION  
ET SOUVENEZ VOUS

" IT'S MAINLY BECAUSE OF THE MEAT "

" C'EST SOUTOUTA CAUSE DES VLANDES "

FOR FURTHER INFORMATION ON OUR  
SPECIALS

DES SPECIAUX

SEE THE BROCHURE WHICH IS BROUGHT  
TO YOUR DOOR.

VOYEZ LA BROCHURE QUE SERA  
DEJIVREE A VOTRE PORTE

LABRADOR CITY

WABUSH

FREE!! FREE!! FREE!!

WE WILL GIVE YOU  
ABSOLUTELY FREE:—

A DRESS SHIRT AND TIE  
WITH EVERY PURCHASE OF A  
MADE TO MEASURE SUIT FROM  
NOW TILL EASTER.

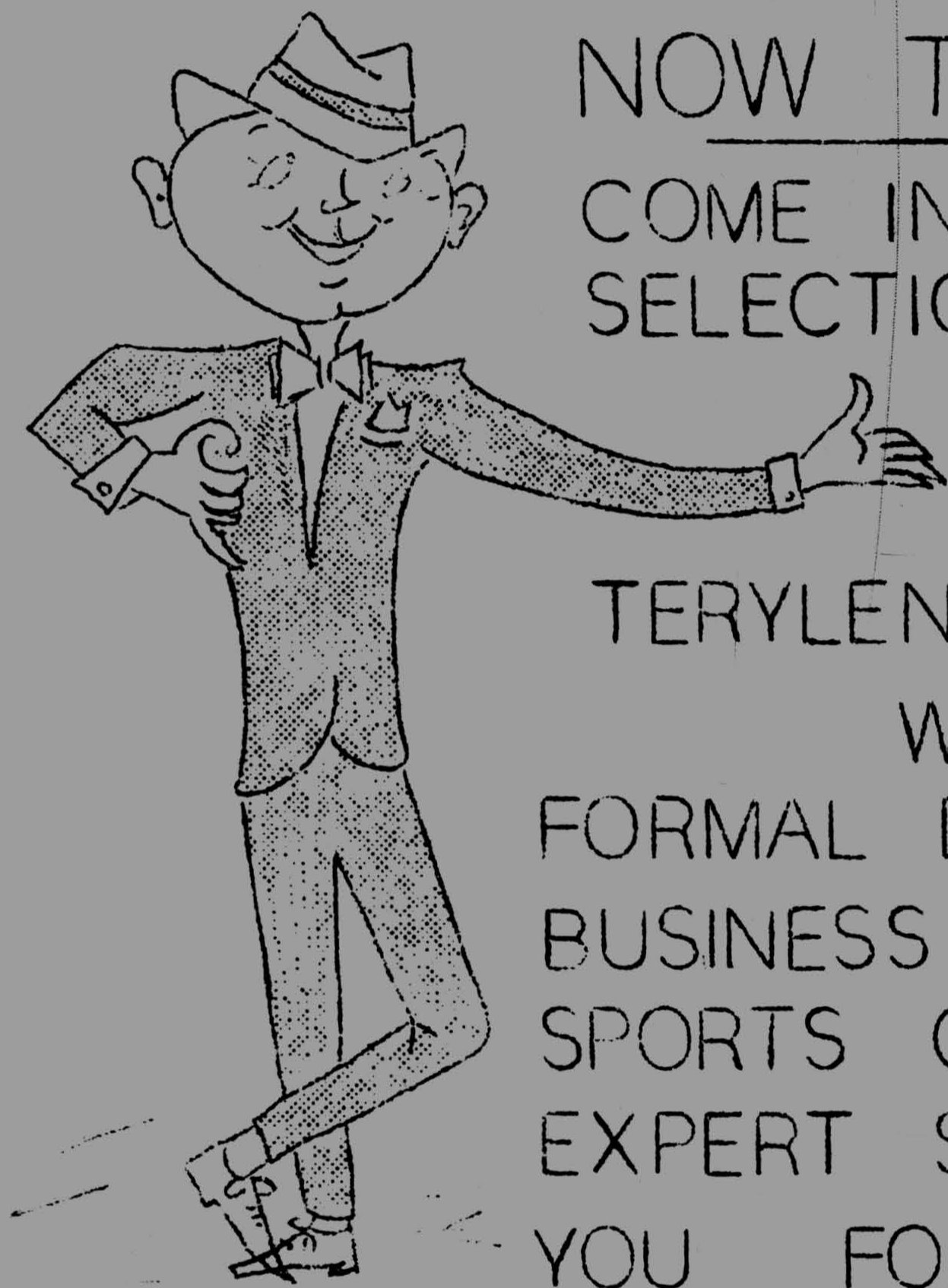

COME IN AND SEE THE WIDE  
SELECTION OF FABRICS FROM  
WHICH TO CHOOSE.

ALL-WOOLS, WOOL &  
TERYLENE, KID MOHAIR & WOOL.

WHETHER YOU NEED A  
FORMAL DRESS SUIT OR A  
BUSINESS OR TROPICAL SUIT OR  
SPORTS COAT & SLACKS, OUR  
EXPERT SALESMEN CAN MEASURE  
YOU FOR A PERFECT

FIT, AT THE SAME PRICE AS  
THESE SUITS ARE SOLD  
ANYWHERE IN CANADA

YOUR SATISFACTION IS  
GUARANTEED WHEN

YOU WEAR A  
SUIT BY "SAVILE ROW."

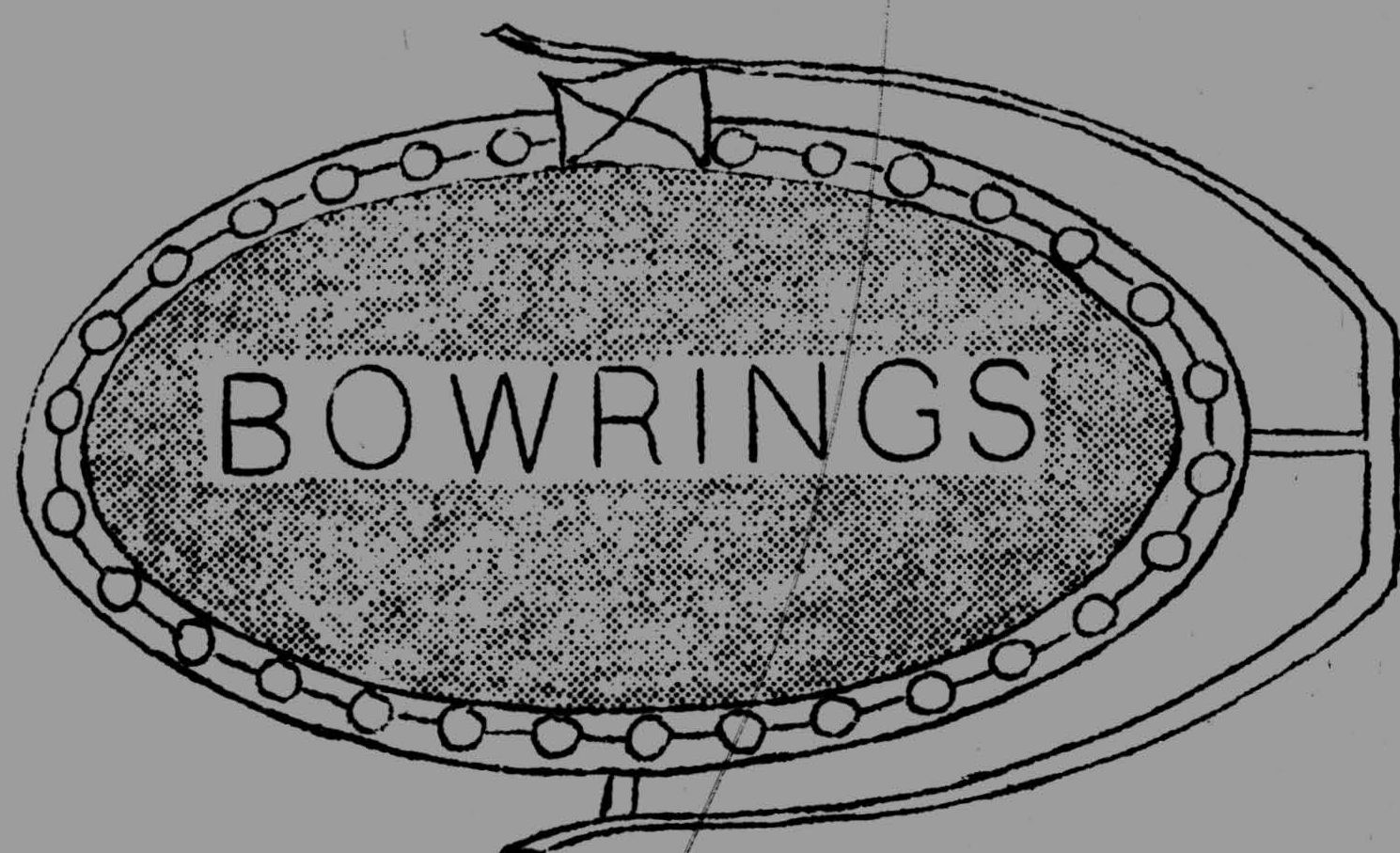

MARCH 28<sup>TH</sup> 29<sup>TH</sup> 30<sup>TH</sup>

AT -

# BOWRINGS

POST "CRISPY NUMBERS"

10oz 3/\$1-00

POST "SUGAR CRISP"

9oz 3/\$1-00

POST "HONEY COMB"

6oz 3/\$1-00

YOUVILLE STRAWBERRY  
JAM

24oz 47¢

BUDGET TOILET  
TISSUE

6/81¢

CHASE & SANBORN  
INSTANT COFFEE

10oz \$1-55

HEAD & SHOULDERS  
SHAMPOO

\$1-23

TORCAN ELECTRIC  
KNIFE

SPECIAL \$14-50

## FRUITS & VEGETABLES

BARTLETT PEARS

8/49¢

GRAPEFRUIT

6/79¢

FRESH CARROTS

21b /43¢

## MEAT MARKET

PORK RIB END

59¢/1b

PORK FILLET END

69¢/1b

MAPLE LEAF BACON

85¢/1b

MAPLE LEAF  
BEEF & PORK  
SAUSAGE

57¢/1b

IT IS HAPPENING THIS WEEKEND AT BOWRINGS BUT WE WILL NOT BE CLOSED. WE ARE MODERNISING OUR SUPERMARKET TO FACILITATE YOUR SHOPPING. WE ASK ALL OUR CUSTOMERS TO BEAR WITH US FOR ANY INCONVENIENCE

THANKS FOR YOUR  
PATRONAGE

# BOWRINGS

LAB. CITY