

Audrey Sumner.

# CAROL NEWS

VOLUME 3

ISSUE 24

BOX 1813

LABRADOR CITY

APRIL 4th, 1968

AUTHORIZED AS SECOND CLASS MAIL BY THE POST OFFICE DEPARTMENT, OTTAWA, AND FOR  
PAYMENT OF POSTAGE IN CASH

THE CANADIAN RED CROSS SOCIETY  
- NEWFOUNDLAND DIVISION -  
\* \* \* \* \*

1968 is Human Rights year and one of the basic rights of everyone is the right to life itself. A man can have no other human or civil rights unless he is alive. There were seventeen thousand and fifty-two Newfoundlanders who, last year, displayed their appreciation for this basic right by donating their blood, so that four thousand, nine hundred and ninety-one men, women and children might live.

Alistair Eaton, Volunteer Chairman of the Red Cross Blood Donor Committee said that although this service was made possible, mainly by blood donors, it is also a joint service, requiring the combined efforts of Volunteer workers, Volunteer donors and Volunteer dollars. All parts of this operation must remain in effect if this essential service is to continue.

Mr. Eaton also revealed that eight hundred and ninety units of fibrinogen, serum albumin, gamma globulin, fresh frozen plasma and cryoprecipitate, which are by-products of blood, were also collected, processed, and distributed free of charge to the patients requiring its use.

Mr. Eaton pointed out that although there has been an increase in the amount of blood collected each year, we should not become complacent, as the need for additional blood, due to the increased number of hospitals and the expanding availability of medical and surgical services, will require everyone's continued support.

On behalf of the four thousand, nine hundred and ninety-one patients who received blood during the past year, Mr. Eaton expressed grateful appreciation to the donors and the dollars that made this service possible.

-----  
INSIDE YOUR CAROL NEWS

CHURCH CALENDAR  
DON'S SPORTS BEAT  
T.V. SCHEDULE

ADVERTISING  
X - WORD

COMING EVENTS  
CHIT-CHAT  
PERSONAL ADS.

EDITOR: MRS A. SUMNER  
TEL. 944-3334

P.O. BOX 1813  
LABRADOR CITY.



COME TO CHURCH  
ON  
SUN. APRIL 7<sup>TH</sup>

PENTECOSTAL CHURCH - GLAD TIDINGS  
TABERNACLE - PASTOR B.H. HARTWELL.

11:00 am Morning Worship  
3:00 pm Sunday School  
7:30 pm Evangelistic Service

MIDWEEK GROUPS:

Thursday (tonight April 4th) Young Peoples Service 8:00 pm  
Tuesday: Prayer Service 8:00 pm

ST PAULS ANGLICAN CHURCH  
REV. L. WHITTEN.

Thursday (tonight April 4th) Junior Choir Practice 6:30 pm

Sunday April 7th:

9:45 am Sunday School  
11:00 am Holy Communion  
7:00 pm Evening Prayer

ST. PETERS ANGLICAN CHURCH - WABUSH  
REV. L. WHITTEN.

8:30 am Holy Communion  
11:00 am Sunday School

CHRIST CHURCH - WABUSH:  
(SERVICES: UPSTAIRS IN RECREATION CENTRE)  
REV. BLAKE WALKER.

Sunday April 4th

9:45 am Sunday School  
11:00 am Morning Worship  
7:00 pm Evening Worship

4:30 pm Senior Teens (30, Bond Ave.)

Wednesday April 10th

Midweek Meeting (30, Bond Ave.)

Building Project

After Supper on Tuesday, Wednesday and Thursday Evenings and during the day on Saturdays.

SALVATION ARMY CITADEL  
CAPTAIN J. CAREW.

11:00 am Holiness Meeting  
2:30 pm Sunday School  
7:30 pm Evangelistic Meeting

Wednesday April 10th.

8:15 pm Band Practice.

OUR LADY OF PERPETUAL HELP  
Rev. O. Desmarais - Rev. F. Lemire.

9:00 am Mass  
11:00 am Mass  
5:00 pm Mass (french)  
7:00 pm Mass

WEEKDAYS: 5:15 pm Mass:

OUR LADY OF THE ASSUMPTION - WABUSH  
Rev. J. Bergeron

10:00 am Mass  
7:00 pm Mass

WEEKDAYS: 5:00 pm Mass (except on FRIDAYS when Mass will be celebrated at 3:30 pm:

CAROL UNITED CHURCH  
REV. ERIC SNIDER

9:30 am Sunday School for Junior 9 - 11 years and Intermediates 12 - 15 years.  
11:00 am Morning Worship (Nursery and Kindergarten 5 years and under and Cradle Roll 2 years and under)  
2:30 pm Primary Sunday School 6 - 8 yrs  
7:15 pm Song Service  
7:30 pm Evening Service.

MIDWEEK GROUPS: AS USUAL.

Easy to get depressed these days, Easy to feel afraid,  
Easy to think the world's gone mad, Easy for dreams to fade.  
But news we hear of things we fear should never blind us to  
The Kindly, splendid, lovely things so many people do.

# M C O U T T O R S

Despite the nasty weather we are experiencing, the Almanac states that summer is not too far distant. The absence of persistent sub-zero temperatures is proof enough for us, and that is why we are now going 'all out' to have our used cars reconditioned for you.

Please read on and carefully scrutinize the list below, then accept our invitation to come over to our lot, and select the car most attractive to you. Cash deals take only a few minutes of your time, Term deals a little longer, but not lengthy enough to bother you. You can still live up to the slogan "Why wait for Spring?"

-----

1964	FORD FALCON	4 door sedan	V-8 engine		
	automatic transmission		radio		\$800.00
1965	CORVAIR MONZA	4 door hard top	two tone		
	6 cylinder engine	automatic transmission	radio		\$1200.00
1965	PONTIAC LAURENTIAN	4 door sedan	two tone		
	V-8 engine	standard transmission			\$1200.00
1966	CORVAIR MONZA	2 door coupe	6 cylinder		
	engine	automatic transmission			\$1500.00
1966	CORVAIR CORSA	2 door coupe	6 cylinder		
	engine	4 speed transmission	radio		\$1300.00
1966	PONTIAC LAURENTIAN	4 door sedan	V-8		
	engine	automatic transmission (two tone)			\$1300.00
1966	PONTIAC TEMPEST G.T.O.	2 door sport			
	coupe	V-8 engine	Automatic transmission		
	radio	console shift			\$2500.00
1966	FORD PICK-UP	½ ton	6 cylinder		
	automatic transmission				\$800.00

-----

WE ALSO HAVE A 1967 PONTIAC PARISIENNE (NEW) 4 DOOR SEDAN WITH A V-8 ENGINE AND AUTOMATIC TRANSMISSION, ALSO RADIO AND POWER STEERING. IN 1967 THIS CAR WAS PRICED AT \$4137.85 BUT SINCE HAS BEEN GREATLY REDUCED - ACTUALLY BY GREATER THAN 15%

-----

CITY MOTORS (LAB) LTD:

PHONE: MR. V.MARCHE

OFFICE: 944 - 2617

HOME: 944 - 5117



# SALE - - VENTE

DU

AU

---

Mesdames, Mesdemoiselles:

Je suis très heureuse de vous annoncer l'arrivée de notre nouvelle marchandise d'été. Vous trouverez maintenant dans notre département des Tissus de quoi faire vos rideaux pour la chambre des enfants, et aussi quelque chose de très bien pour agrémenter votre cuisine et vos chambres. De plus, nous avons en main les nouveaux tissus pré-doublés, les cotonnades de teintes unies (10 couleurs pour vous plaire), et des tissus quatre-saisons. Pourquoi ne pas venir et vous rendre compte par vous-même?

De plus, pour celles qui préfèrent les patrons VOGUE, nous avons le livre de comptoir à votre disposition et une livraison de 10 jours nous a été garantie par la compagnie.

Mrs, Misses:

I am very pleased to announce you the arrival of our new Spring and Summer materials. You will now find something for your nursery, your kitchen and your bedrooms. More, we also have the latest in textiles: the bounded materials for your suits and your dresses. We also received cotton in plain shades (10 colors to please you), and we must not forget our four-seasons material. Why not come and see by yourself?

For those who prefer VOGUE patterns, we have the counter book available and delivery of 10 days was promised by the company, on all orders.

---

TEL.: 944-2270

RAYMOND BOUCHARD

SHOPPING CENTRE

*Men's Wear*

LABRADOR CITY

# SALE - - VENTE

DU

AU

5 AVRIL

13 AVRIL

## EASTER SALE AT BOUCHARD MEN'S WEAR

Easter is coming quite fast. It is now the time to buy yourself a very dressed SUIT CLOTHES and you will get free the matching accessories as follows:

I white shirt: \$5.50	Free
I cufflinks : \$14.95	Free
I Wool socks : \$ 1.75	Free

### EXTRA SPECIAL

#### FRIDAY ONLY

With every dressed pants you are going to buy, you will get 1/3 OFF on all the sportshirts.

OPEN EVERY NIGHT UNTIL 7 O'CLOCK

FRIDAY UNTIL 9 O'CLOCK, SATURDAY UNTIL 6 O'CLOCK

## VENTE DE PAQUES A LA MERCERIE BOUCHARD

Pâques approche rapidement. Il est grand temps de vous procurer un très bel habit de toilette pour cette occasion. Nous vous donnons les accessoires suivants qui vont completer le tout avec éclat:

I chemise blanche :\$5.50	Gratuit
I bouton de manchette:\$14.95	Gratuit
I paire de bas :\$1.75	Gratuit

### EXTRA SPECIAL

#### VENDREDI SEULEMENT

Si vous achetez une paire de pantalons de toilette, vous obtenez

une réduction de 1/3 sur toutes les chemises sport.

TEL.: 944-2270

# RAYMOND BOUCHARD

SHOPPING CENTRE

*Men's Wear*

LABRADOR CITY

JEWELLER AT BOUCHARD MEN'S WEAR

FOR ALL YOUR REPAIRS ON WATCHES, RINGS  
AND JEWELS OF ALL KINDS.

WE GIVE ONE-YEAR GARANTY ON ALL CLEANINGS

**mouvement à remontage automatique**

movement with self-winding device

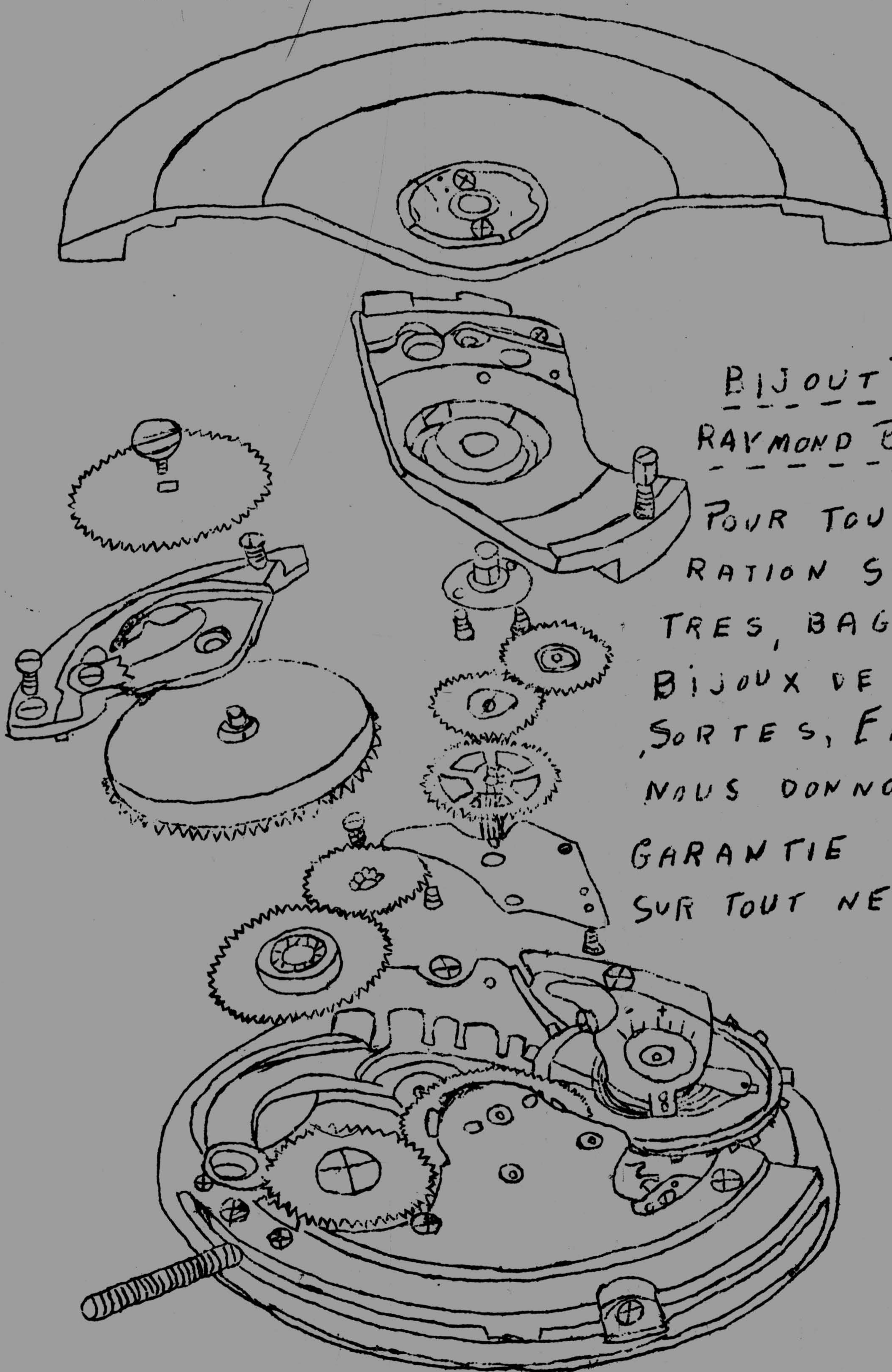

BIJOUTIER CHEZ  
RAYMOND BOUCHARD

POUR TOUTE RÉPA-  
RATION SUR MON-  
TRES, BAGUES ET  
BIJOUX DE TOUTES  
SORTES, EN PLUS,  
NOUS DONNONS UNE  
GARANTIE DE 1 AN  
SUR TOUT NETTOYAGE.

**EBAUCHES S.A., NEUCHÂTEL**

SWISS MADE

ANNUAL SKI MEET 1968

SMOKEY MOUNTAIN SKI CLUB

		<u>DOWNHILL</u>	C	<u>SLALOM</u>	C	<u>G. SLALOM</u>	C	<u>COMBINED</u>	C
			L		L		L		L
			U		U		U		U
			B		B		B		B
MEN SENIOR 18 and Over	1	D.Mattinson	SM	M.Muenzel	SM	M.Muenzel	SM	M.Muenzel	SM
	2	C.Mosely	SM	D.Mattinson	SM	D.Mattinson	SM	D.Mattinson	SM
	3	M.Muenzel	SM	Coco Roy	SM	U.Munstermann	G	Coco Roy	SM
LADIES SENIOR 18 and Over	1	C.Sheppard	SM	L.Benedek	SM	C.Sheppard	SM	L.Benedek	SM
	2	K.Obrazcova	SM	J.Torrance	G	J.Torrance	G	K.Obrazcova	SM
	3	P.Leonfellner	SM	K.Obrazcova	SM	C.Casault	G	C.Sheppard	SM
BOYS JUNIOR A 14 to 17 incl.	1	D.Dunkin	SM	B.Archer	SM	D.Dunkin	SM	D.Boily	G
	2	D.Boily	G	D.Boily	G	D.Boily	G	B.Archer	SM
	3	B.Archer	SM	D.Batson	SM	D.Batson	SM	D.Batson	SM
GIRLS JUNIOR A 14 to 17 incl.	1	D.Couturier	G	J.Hardie	SM	D.Couturier	G	D.Couturier	G
	2	M.Whaley	G	D.Couturier	G	D.Champoux	G	M.Whaley	G
	3			D.Champoux	G	B.McLean	G	D.Champoux	G
BOYS JUNIOR B 12 and 13	1	K.Swierkot	SM	R.Timmons	SM	S.Corbiel	SM	K.Swierkot	SM
	2	L.Brown	SM	L.Brown	SM	R.Timmons	SM	L.Brown	SM
	3	A.Lauzier	G	K.Swierkot	SM	L.Brown	SM	R.Timmons	SM
GIRLS JUNIOR B 12 and 13	1	K.Plue	SM	C.Lauzier	G	C.Cunningham	SM	C.Cunningham	SM
	2	C.Cunningham	SM	D.Hogan	G	K.Plue	SM	C.Lauzier	G
	3	C.Lauzier	G	H.Allen	G	H.Allen	G	D.Hogan	G
BOYS JUNIOR C 10 and 11	1	B.Dunkin	SM	R.Jardine	SM	R.Jardine	SM	R.Jardine	SM
	2	P.Spitznagel	SM	M.Guimond	SM	B.Dunkin	SM	B.Dunkin	SM
	3	R.Jardine	SM	B.Dunkin	SM	P.Spitznagel	SM	P.Spitznagel	SM
GIRLS JUNIOR C 10 and 11	1	S.Jerome	SM	R.Hardie	SM	S.Jerome	SM	R.Hardie	SM
	2	R.Hardie	SM	N.Plue	SM	R.Hardie	SM	S.Jerome	SM
	3	N.Plue	SM	A.Blais	BL	N.Plue	SM	N.Plue	SM
BOYS JUNIOR D 8 and 9	1			R.Archer	SM	R.Archer	SM	R.Archer	SM
	2			M.Mattinson	SM	G.Dunkin	SM	M.Mattinson	SM
	3			A.Anderson	BL	M.Mattinson	SM	A.Anderson	BL
GIRLS JUNIOR D 8 and 9				P.Crook	SM	S.Mattinson	SM	P.Crook	SM
				H.Champoux	G	H.Champoux	G	H.Champoux	G
						P.Crook	SM	S.Mattinson	SM
BOYS JUNIOR E Under 8	1					C.Mattinson	SM		
	2					J.Burchert	SM		
	3					C.Jardine	SM		
GIRLS JUNIOR E Under 8	1					L.Archer	SM		
	2					J.Anderson	BL		
	3					S.Jardine	SM		

G: Gallix Ski Club, Sept-Iles, SM: Smokey Mountain Ski Club Labrador City, BL: Bean Lake Ski Club, Schefferville

These are the results of a very successful Ski Meet. The visiting Clubs were the Gallix Ski Club from Sept-Iles with thirty Skiers and the Bean Lake Club from Schefferville with twenty Skiers.

The Smokey Mountain Ski Club won the event with a total of 164 Points; second was the Gallix Ski Club with 50 Points

PERSONAL ADS:

FOR SALE:

Chesterfield and two chairs

Household furniture for sale

Four Maternity Dresses

Crib with mattress

Ironing board    Baby carriage    Lamps  
Automatic Washer    Dryer    Playpen    Single Bed.

Baby carriage (used only a year)

Plymouth Fury (1966) 2 door hardtop  
V-8 automatic    Power steering    Power Brakes

Small baby crib

PLEASE RING:

944 - 5290 after 5:00 pm:

944 - 2412

944 - 5618

944 - 5765

944 - 2412

944 - 3359

944 - 2162

944 - 2260

WANTED TO BUY:

High Boy or something suitable for child's room.

Boys bicycle - about 24" wheel

Shelves, chest of drawers-suitable for basement.

HELP WANTED:

Woman wanted for housework (1 or 2 days per week)

LOST:

Brown book bag (name: DAVID MATTHEWS inside) Lost  
between McManus School and Carol Drive.

ACCOMODATION REQUIRED:

Couple require house, apartment or trailer to rent

944 - 5765

944 - 5478

944 - 3334

944 - 2998

944 - 5148

944 - 5653

- SIMPLE RECIPES TO CUT OUT AND KEEP -

INGREDIENTS

6 oz puff (or flaky) pastry  
Whipped cream or  
confectioner's custard  
vanilla essence  
Raspberry or strawberry jam  
White glacé icing

VANILLA SLICES

Roll the pastry  $\frac{1}{4}$  inch thick and form into a strip 4 inches wide. Cut into oblong pieces about  $1\frac{1}{2}$  wide and bake in a very hot oven (475° F.) for 10 minutes. Allow to become quite cold, then sandwich two or three of them together with jam and cream, which should be flavoured with vanilla. Top the slices with a little white glacé icing. Serve these pastries as a cold dessert, or for tea. If preferred, fresh strawberries or raspberries can be used for the filling instead of the jam.

( Makes 8 - 12 slices )

METHOD

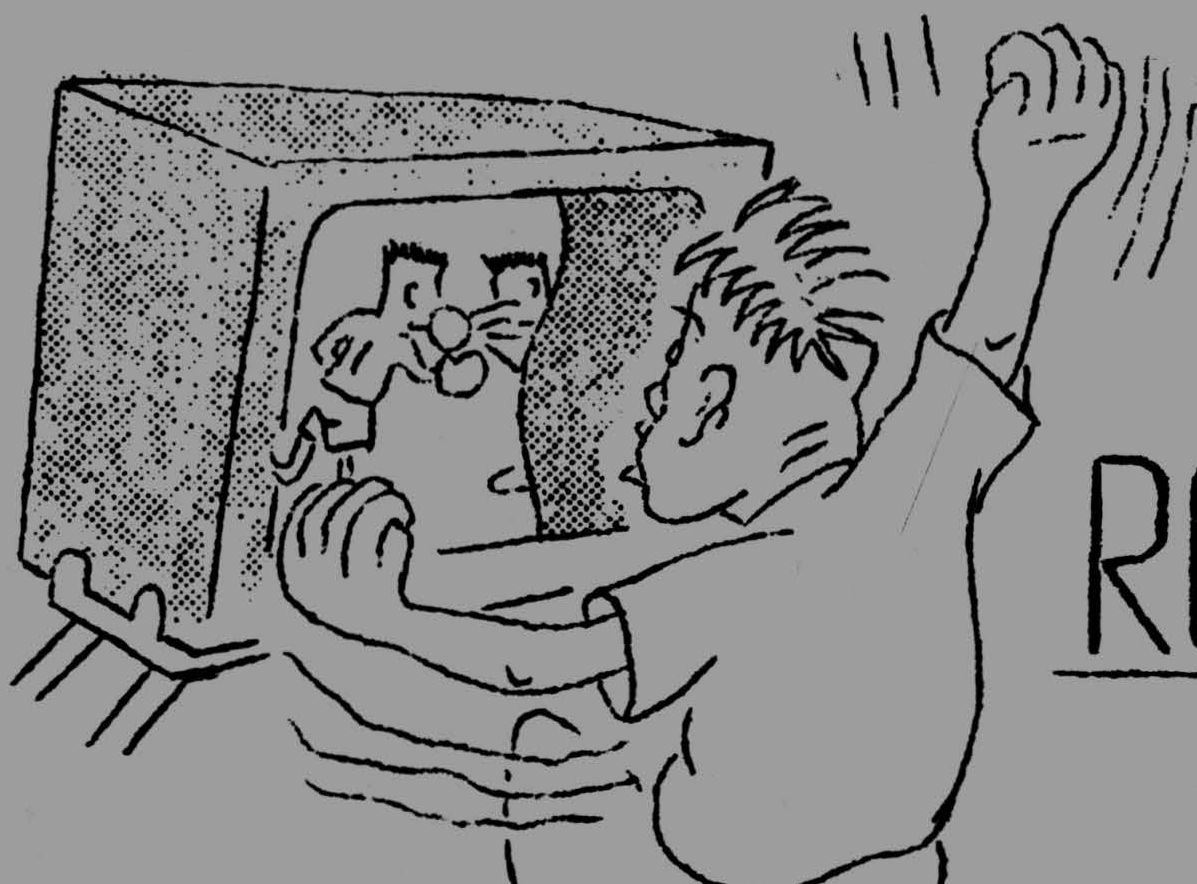

TV REPAIR

RECORD PLAYERS

STEREOS

TAPE RECORDERS

RADIOS

HI - FI ETC:

SERVICE DAY AND NIGHT .....

ALL WORK GUARANTEED .....

PHONE: TERRY WYATT / 944-2217  
MARCEL LYONNAIS / 944-5327

- T. V. SCHEDULE -

MONDAY THROUGH FRIDAY

4:00 4:30 The Edge of Night  
 4:30 5:00 Bonny Prudden  
 5:00 5:30 Take 30  
 5:30 6:00 Bobino  
 6:00 6:30 La Boite a Surprises

THURSDAY APRIL 4th

3:30 4:00 Canadian School Telecast  
 6:30 7:00 Upside Town  
 7:00 7:30 Let's Go !  
 7:30 8:00 Green Acres  
 8:00 8:30 Hogan's Heroes  
 8:30 9:00 Telescope  
 9:00 9:30 A la Seconde  
 9:30 10:00 Camera '68  
 10:00 10:30 Winter Olympics (part 1)  
 10:30 11:00 Winter Olympics (part 2)  
 11:00 11:10 C.B.C.News

FRIDAY APRIL 5th

6:30 7:00 Upside Town  
 7:00 7:30 Winter Olympics  
 7:30 8:30 Perdus dans L'espace  
 8:30 9:00 Get Smart  
 9:00 9:30 The Tommy Hunter Show  
 9:30 10:00 The Public Eye  
 ( Walter Gordon -special)  
 10:00 10:30 Peter Nero  
 10:30 11:00 In Person  
 11:00 11:10 C.B.C.News  
 11:10 Late Night Theatre -  
 ' SPRING REUNION ' with  
 Betty Hutton, Dana Andrews, Jean Hagen  
 and James Gleason.

SATURDAY APRIL 6th

4:00 5:00 C.B.C.Sports (Curling)  
 5:00 5:30 Tour de Terre  
 5:30 6:00 Bidule Tarmacadam  
 6:00 6:30 To be announced  
 6:30 7:00 Bugs Bunny  
 7:00 7:30 The Mark of Zorro  
 7:30 8:00 This Land of Ours  
 8:00 8:30 The Beverly Hill Billies  
 8:30 10:30 N.H.L.Hockey -  
 ' CHICAGO at TORONTO '  
 10:30 11:00 Les Couche Tard  
 11:00 11:10 C.B.C.News  
 11:10 Cinema - ' PASSION FATALE '  
 avec Gregory Peck et Ava Gardner.

SUNDAY APRIL 7th

4:00 4:30 Man Alive  
 4:30 5:00 Hymn Sing  
 5:00 5:30 La Vie Qui Bat  
 5:30 6:00 Les Hommes des L'espace  
 6:00 6:30 Frankenstein Junior  
 6:30 7:30 The Ed Sullivan Show  
 7:30 8:00 Flashback  
 8:00 8:30 Cher Oncle Bill  
 8:30 9:00 Commande du Desert  
 9:00 10:00 Bonanza  
 10:00 11:00 The Way It Is  
 11:00 Winter Olympics

MONDAY APRIL 8th

6:30 7:00 Forest Rangers  
 7:00 7:30 Let's Go !  
 7:30 8:30 Le Paradise Terrestre  
 8:30 9:30 Show of the Week  
 9:30 10:00 Front Page Challenge  
 10:00 11:00 The Carol Burnett Show  
 11:00 11:10 C.B.C.News

TUESDAY APRIL 9th

3:30 4:00 Canadian School Telecast  
 6:30 7:00 Upside Town  
 7:00 7:30 Let's Go !  
 7:30 8:30 The Red Skelton Hour  
 8:30 9:00 Rue de Pignons  
 9:00 9:30 A Guichet Ferme  
 9:30 10:30 WOJECK  
 10:30 11:00 The Public Eye  
 11:00 C.B.C.News

WEDNESDAY APRIL 10th

6:30 7:00 Upside Town  
 7:00 7:30 Let's Go !  
 7:30 8:00 D'Iberville  
 8:00 8:30 Moi et L'autre  
 8:30 9:30 Mission Impossible  
 9:30 11:00 Festival presents:-  
 ' SOLDIERS OF THE WIDOW '  
 11:00 11:10 C.B.C.News

T.V. SCHEDULE IS SUBJECT TO  
 CHANGE WITHOUT ANY NOTICE:  
 .....

oooooooooooo

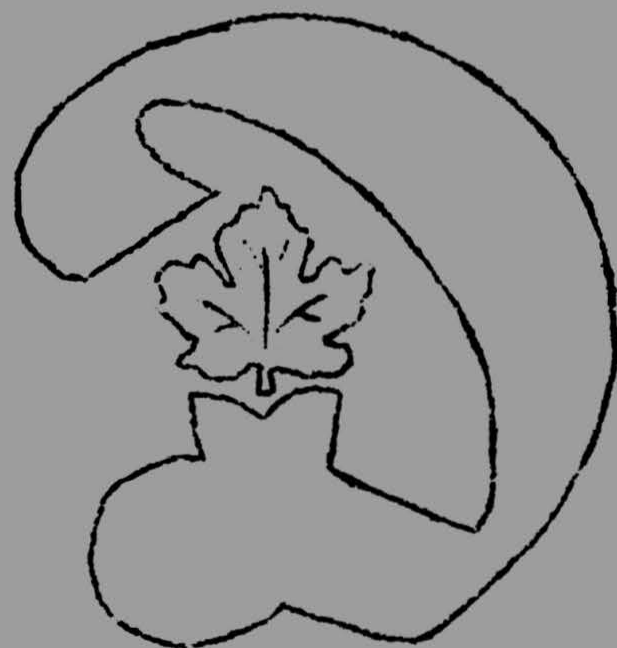

**DOMINION  
 STORES**

SHOP AT YOUR FRIENDLY DOMINION STORE

ARRETES A VOTRE MAGASIN DOMINION

AND REMEMBER

ET SOUVENEZ VOUS

" IT'S MAINLY BECAUSE OF THE MEAT "

"C'EST SURTOUT A CAUSE DES VIANDES"

FOR FURTHER INFORMATION ON OUR

DES SPECIAUX

SPECIALS

VOYEZ LA BROCHURE QUE SERA

SEE THE BROCHURE WHICH IS BROUGHT  
 TO YOUR DOOR

DELIVREE A VOTRE PORTE

LABRADOR CITY:

WABUSH:

# EASTER GIFT SUGGESTIONS

FROM

BOWRINGS

MENS TIE & PUFF  
SETS

\$2-50 - 5-00

MENS HOSE & TIE  
SETS

\$2-50 - 3-50

MENS CUFF LINK  
SETS

UP TO \$17-50

PURE SILK TIES  
BY CHRISTIAN DIOR

NEW STYLES IN  
MENS PULLOVERS  
PASTEL SHADES

\$14-95 - 16-95

SPECIAL  
A SELECTION OF  
LADIES SHELLS  
IN ASSORTED  
SHADES

SPECIAL \$3-00

LUGGAGE SETS

\$39-95 UP

LADIES HANDBAGS

\$6-00 - 10-00

COTTON GLOVES

\$2-00 - 3-00

"CHANEL" COLOGNES  
& PERFUMES

\$4-00 - 8-00

SLIP & PANTY  
SETS

\$4 00

LADIES NEGLIGEE  
SETS

\$15-00 - 20-00

LADIES SLIPPERETTES

\$3-00 - 5-00

EASTER

SHOPPING HOURS

THUR APRIL 11<sup>TH</sup> 9-00AM  
-9-00PM

GOOD FRIDAY - CLOSED

SAT APRIL 13<sup>TH</sup> 9-00AM  
-6-00PM

EASTER MON. - CLOSED  
APRIL 15<sup>TH</sup>

BOWRINGS  
LABRADOR CITY

# ELECTROLUX

(CANADA) LTD

THE WORLD'S MOST IMITATED  
CLEANER AND THE WORLD'S ONLY  
FULLY AUTOMATIC CLEANER.....

THE  
ZB 88

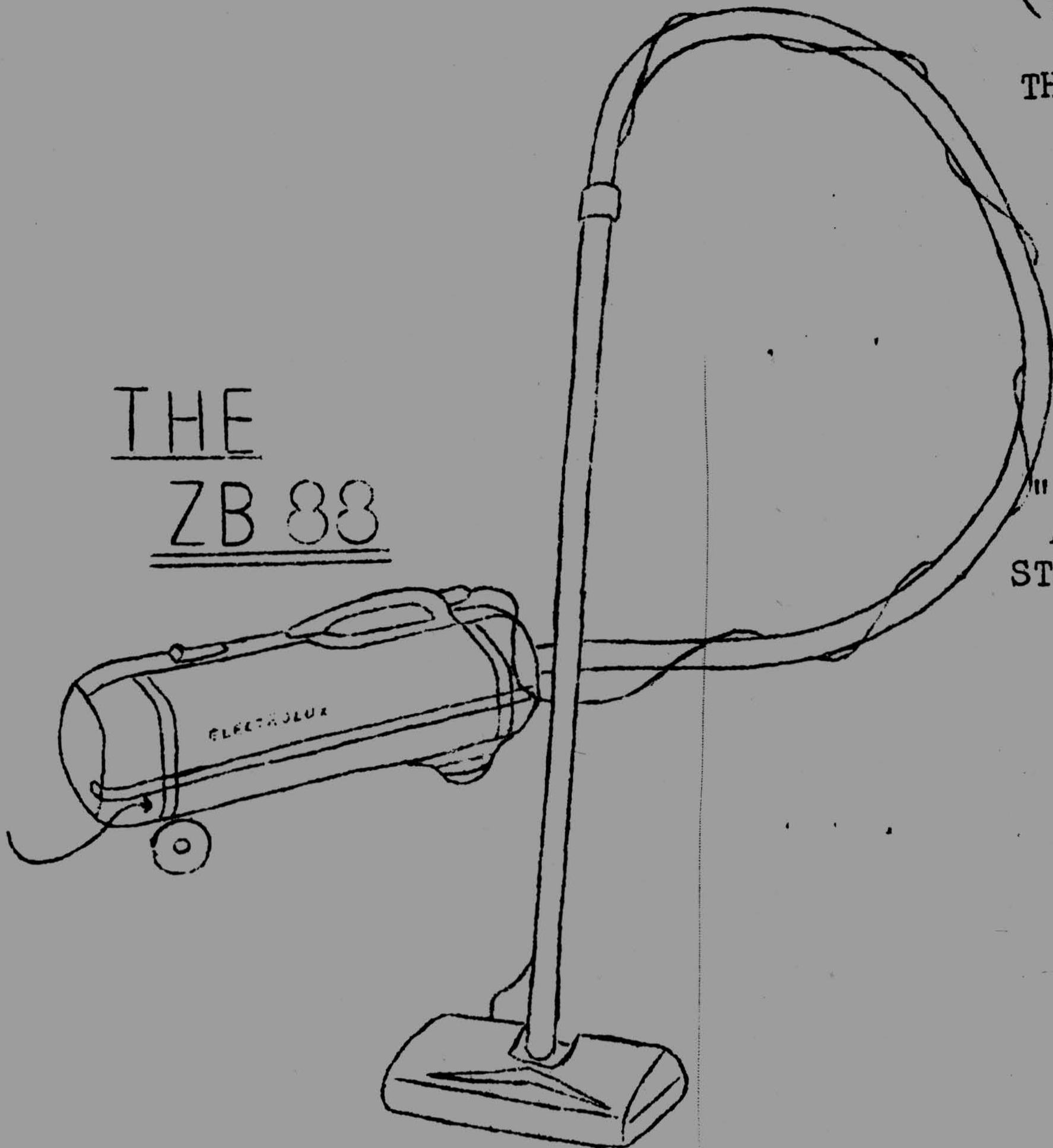

FEATURING THE FAMOUS  
Z B. 88 VACUUM  
CLEANER WITH THE  
" POWER NOZZLE "  
AND AN OPTIONAL  
STOWAWAY CHEST.

ALSO THE LATEST FLOOR AND RUG  
CONDITIONER - THE BX 20 FLOOR  
POLISHER, WHICH SCRUBS YOUR  
FLOORS, SHAMPOOS YOUR RUGS,  
AND POLISHES YOUR FLOOR, ALL  
WITH THE SAME MACHINE.

---  
YOU WOULD HAVE TO SEE THIS  
WONDERFUL MACHINE TO FULLY  
APPRECIATE ITS VALUE.

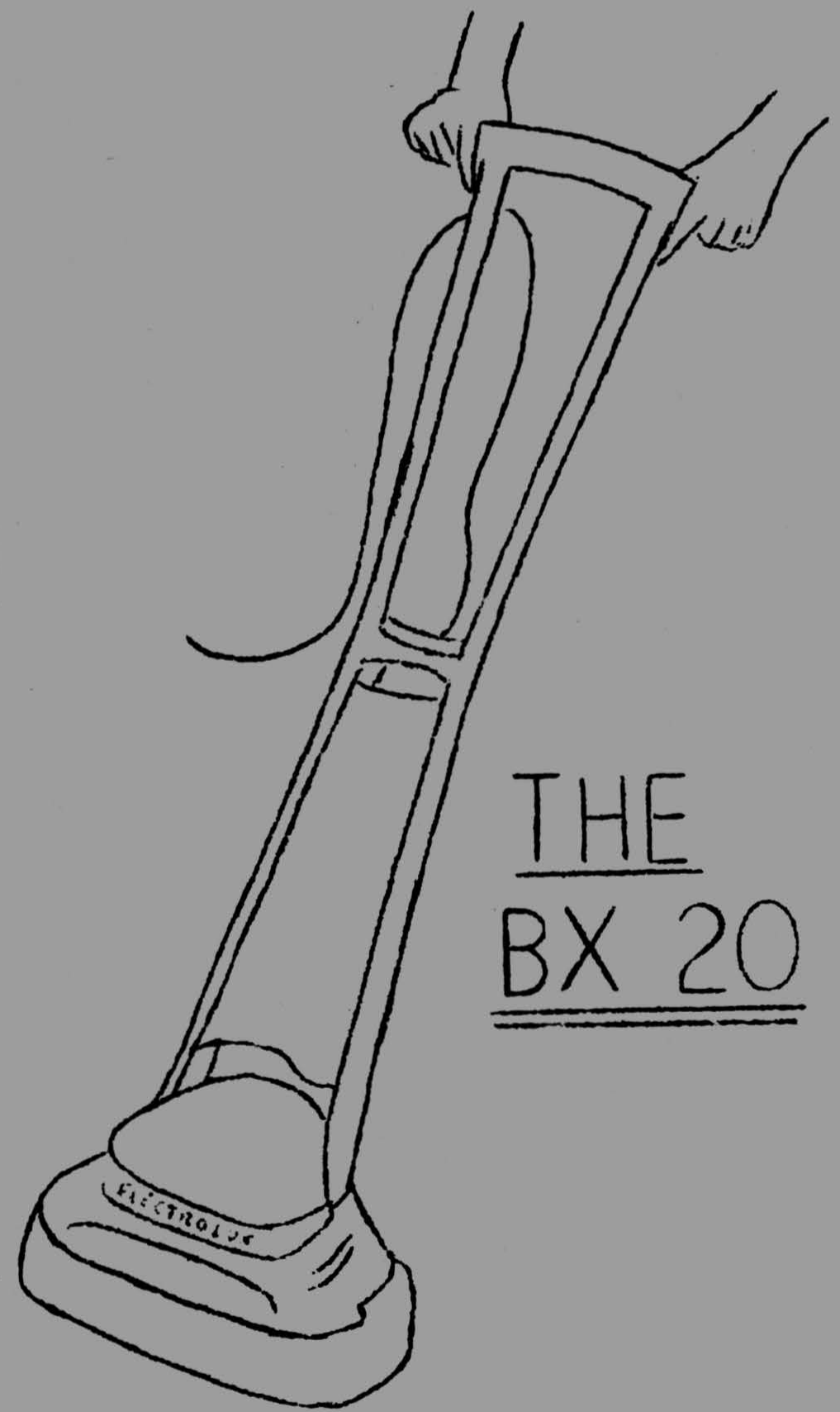

THE  
BX 20

YOUR ELECTROLUX REPRESENTATIVE IN LABRADOR  
CITY WILL BE PLEASED TO GIVE YOU A FREE  
DEMONSTRATION.

WHY NOT GIVE ME A CALL, AND TAKE ADVANTAGE  
OF OUR VERY EASY TERMS???

WE HAVE IMMEDIATE DELIVERY, AND STOCK EVERY-  
THING FOR YOUR FUTURE NEEDS.

FOR MORE INFORMATION - PLEASE CALL:..... 944 - 2215 or 944 - 2361

A FULL 2-YEAR GUARANTEE ON

ALL OUR PRODUCTS

ELECTROLUX REPRESENTATIVE  
FOR LABRADOR CITY & WAPUSH

LEN LEYTE

8 HOUR

FURNITURE  
SHOPPING

SPREE

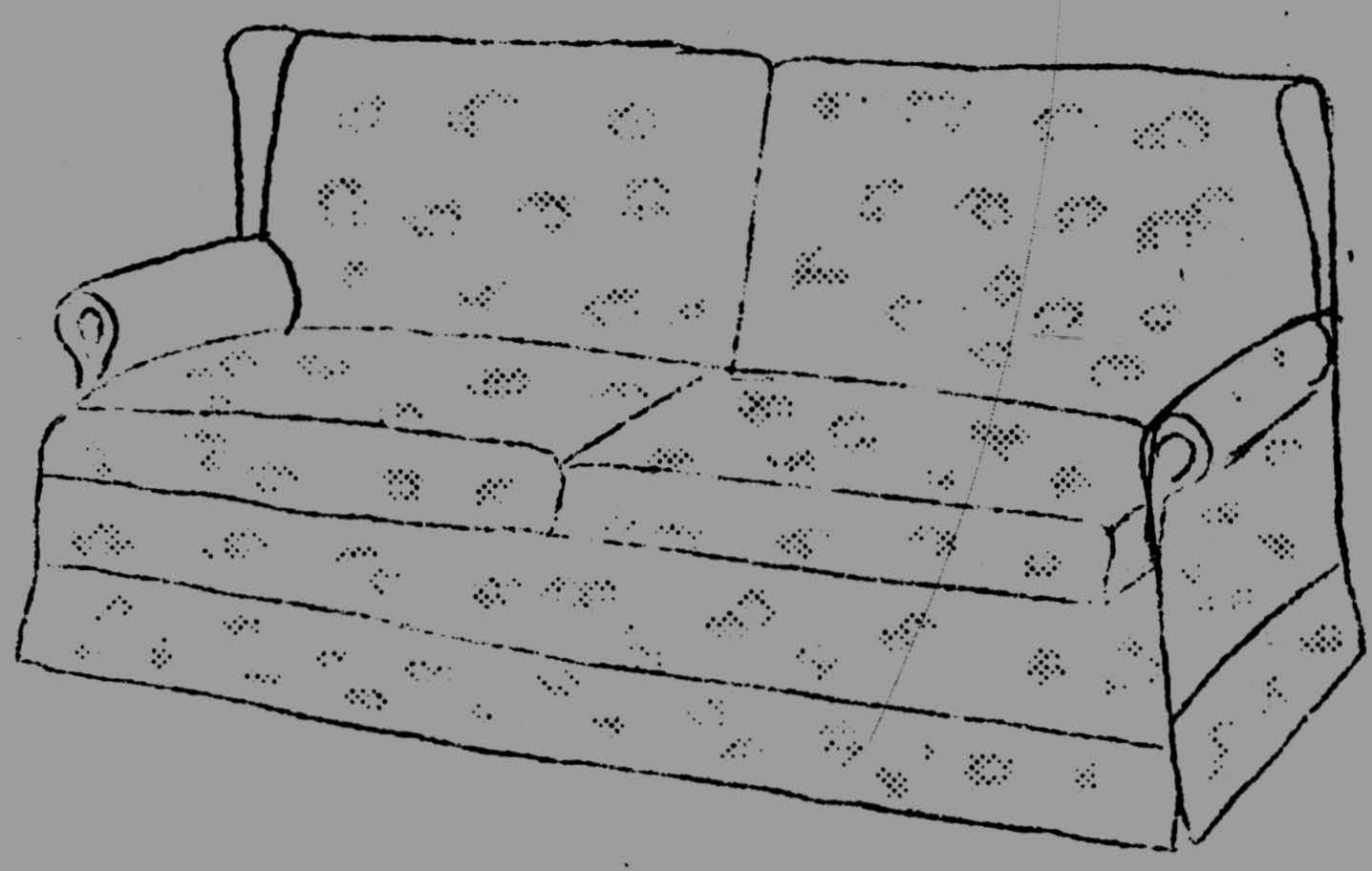

MONDAY  
ONLY

CUTTING ALL  
COSTS

MONDAY  
ONLY

20 % OFF

ALL FURNITURE  
AND WESTINGHOUSE  
APPLIANCES

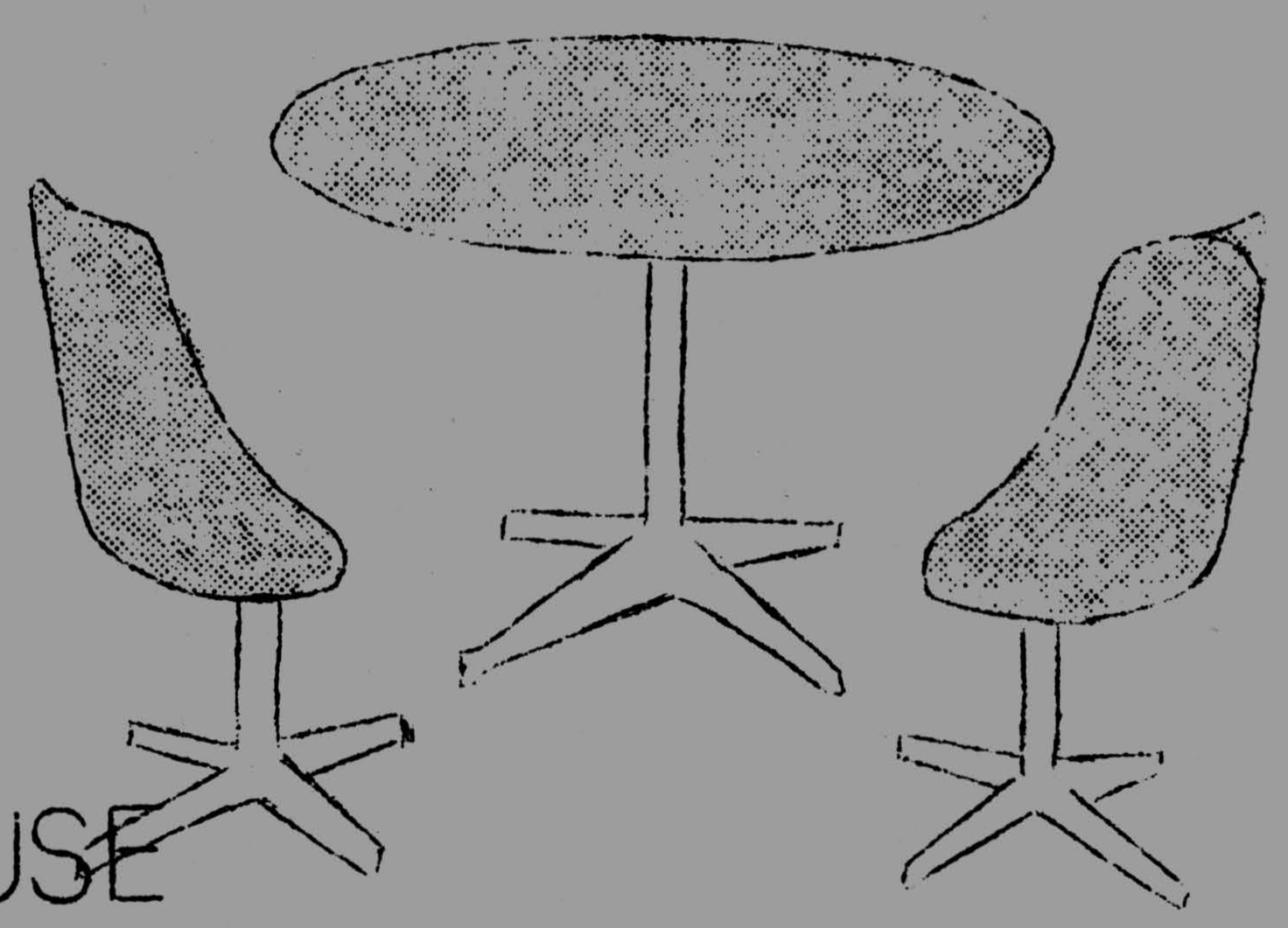

EXCEPT THOSE ALREADY MARKED  
DOWN

CARRY IT AWAY  
YOURSELF

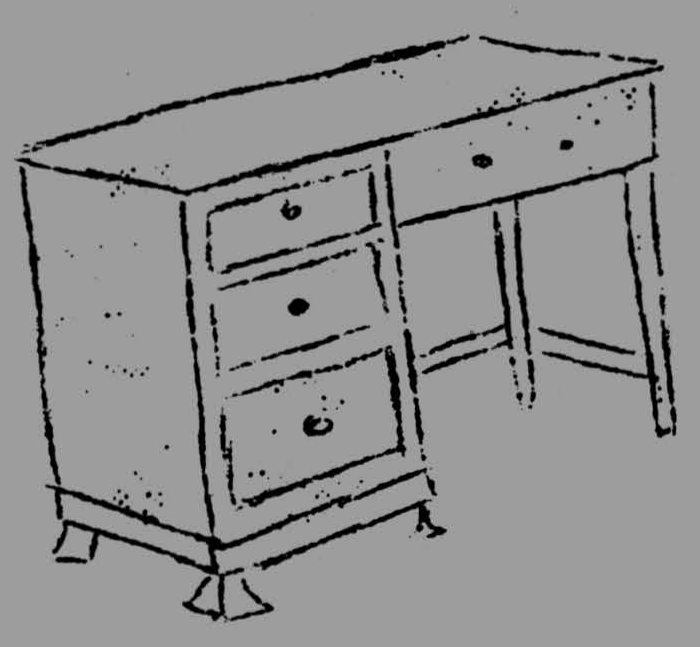

OPEN MONDAY  
APRIL 8<sup>TH</sup> 9 AM - 6 PM

CLOSED FRIDAY  
APRIL 12<sup>TH</sup>

AYRES  
FURNITURE  
DEPARTMENT  
WABUSH  
PLAZA

# AYRES "NITELITE" SPECIALS

ONE RACK ONLY  
LADIES SKIRTS IN  
COTTON WOOL &  
FLANNEL LARGE  
ASSORTMENT OF  
STYLES SIZES 8-16  
Reg \$5-98 - 12-98  
"NITELITE" \$3-99

EXTRA SPECIAL  
LADIES COTTON &  
FLANNELETTE LONG  
PYJAMAS S-M-L  
Reg to \$5-00  
"NITELITE" \$1-99

EASTER TOY SPECIAL  
SKIPPING ROPE &  
EASTER EGG  
OR  
TOY TRUCK &  
EASTER EGG  
Reg 49¢  
"NITELITE" 24¢

A GROUP OF MENS  
SPORTS SHIRTS IN  
ASS'T'D SHADES &  
STYLES, ALSO DRESS  
SHIRTS. FAMOUS  
BRAND NAMES  
VALUES TO \$10-99  
"NITELITE" \$4-66

A GROUP OF MENS  
SUITS ALL WOOL  
SIZES 34-42  
Reg \$49-95 / \$89-95  
25% OFF

A LARGE GROUP OF  
KIDDIES SHIRTS POP  
TOPS & PEDDLE  
PUSHERS  
2-6X  
"NITELITE" 50¢

*Ayres* LTD  
WABUSH  
THUR & FRIDAY  
9AM to 9PM

# SPORTS BEAM <sup>by "DON"</sup>

This is the time of year when hockey fever hits Canada. It's Stanley Cup play-off time. Who's going to win the big prize? I would like to see Boston come out on top, but this won't be as Montreal will take them in the Semi-final. New York should take Chicago and then get revenge for last year by upending the Canadiens. As far as east vs west, it's just a matter of going through the paces. I would like to see Boston win but have to go with the Rangers to win the 1968 Stanley Cup.

Another big wee-end for local Hockey fans as the Braves tangle with the Maritime Intermediate "A" hockey champs. Games will be played Friday, Saturday and Monday nights at 8:00 pm: The locals defeated the St. John's Junior Cap's 5 - 4 last week-end and but for the tremendous goal keeping of Leon Cote could have lost. If they hope to win over the week-end the name of the game will have to be back-checking. Lack of back-checking was fairly obvious against the Cataracts and the boys will have to improve if they hope to win the upcoming series.

See where coach Hogan has picked up Veteran Doug Squires and goaltender Dave Dowden from the Island along with Dr. Mosley from our local league. He's still allowed one more and there are some mighty good hockey players on the Island.

I guess my prediction on the boxing fell flat, as the Wabush boys won only two bouts. Either the Island clubs are stronger than I thought or the local club is weaker. It could be a combination of both.

See where the outside clubs will be visiting Wabush. This should be a good night for local fight fans.

This week-end has the Men's Invitational Curling Bonspiel taking place at the Carol Curling Club. Judging from the out of town entries it promises to be a competitive spiel. Sure hope the weather changes allowing the visitors to get in.

Broomball has really caught on at the arena and the reaction from the 130 odd guys participating is tremendous, they are really enjoying it. Below is a brief picture of standings to date along with the top 4 goal scorers. Assists are not credited.

TEAM	G.P.	STANDINGS			G.F.	G.A.	PTS.
		W	L				
BRAVES	3	3	0	21	7	6	
LAB	3	3	0	12	5	6	
WABUSH	3	2	1	17	15	4	
ROYALS	2	1	1	14	5	2	
ROCKETS	2	1	1	12	4	2	
MILL	3	1	2	10	11	2	
WARLOCKS	2	0	2	6	17	0	
AVENGERS	2	0	2	6	19	0	
WAREHOUSE	2	0	2	2	16	0	

GOAL SCORERS			
NAME	TEAM	GAMES	GOALS
HUNTER	ROYALS	2	6
CHIPPMAN	BRAVES	3	6
MCHUGH	BRAVES	3	4
WOODMAN	WABUSH	3	4

That's 'thirty' for this week and remember "If you can't take part in sport be a good one anyway."

## INSURANCE

FIRE

CONTACT

AUTO

## BOWRINGS INSURANCE

MARINE

(A DIVISION OF BOWRING BROS. LTD)

MISC

THE MALL - SHOPPING CENTRE  
LABRADOR CITY

MANAGER: MRS VIRGINIA CAVERLY  
PHONE: 944-5388.



# LABRADOR CITY ARENA

WEEKLY

SCHEDULE

THURSDAY APRIL 4th	LADIES & TOTS MINOR HOCKEY BROOMBALL LAB. vs ROYALS ROCKETS vs MILL BRAVES PRACTICE	10:00 am 4:45 pm to 6:45 pm  7:30 pm 9:00 pm 10:30 pm
FRIDAY APRIL 5th	CASUAL RENTALS MINOR HOCKEY EXHIBITION HOCKEY	8:00 am to 3:00 pm 4:45 pm to 6:45 pm 8:00 pm
SATURDAY APRIL 6th	MINOR HOCKEY PUBLIC SKATING FIGURE SKATING EXHIBITION HOCKEY	8:00 am to 1:00 pm 2:00 pm to 4:00 pm 4:30 pm to 6:00 pm 8:00 pm
SUNDAY APRIL 7th	CASUAL RENTALS PUBLIC SKATING MINOR HOCKEY FIGURE SKATING PUBLIC SKATING	8:00 am to 1:00 pm 2:00 pm to 4:00 pm 4:30 pm to 6:00 pm 6:30 pm to 8:00 pm 8:30 pm to 10:30 pm
MONDAY APRIL 8th	CASUAL RENTALS MINOR HOCKEY EXHIBITION HOCKEY IF NECESSARY.	8:00 am to 4:00 pm 4:45 pm to 6:45 pm 8:00 pm
TUESDAY APRIL 9th	LADIES & TOTS MINOR HOCKEY BROOMBALL BRAVES vs LAB. WAREHOUSE vs MILL	10:00 am 4:45 pm to 6:45 pm  7:30 pm 9:00 pm
WEDNESDAY APRIL 10th	MINOR HOCKEY PUBLIC SKATING	4:45 pm to 6:45 pm 8:30 pm to 10:30 pm

## EXHIBITION HOCKEY

### EASTERN CANADIAN INTERMEDIATE "A" CHAMPIONSHIPS

FRIDAY APRIL 5th	8:00 pm:
SATURDAY APRIL 6th	8:00 pm:
MONDAY APRIL 8th	8:00 pm: (IF NECESSARY)

THE TICKET BOOTH WILL OPEN AT 7:00 pm FOR ALL  
GAMES - NO ADVANCE SALES.

ADMISSION ADULTS \$1.50  
CHILDREN ACCOMPANIED BY AN ADULT \$0.25

# WOOLWORTHS EASTER

EASTER BUNNIES WILL BE PARADE  
AT WOOLWORTHS ON FRIDAY & SAT'DAY  
TO HELP WITH YOUR EASTER SHOPPING

SMILES 'N CHUCKLES  
FUNNY BUNNIES  
\$1-19

NAME EGGS  
YOUR NAME WRITTEN  
ON WHILE YOU WAIT  
69¢

FILLED EASTER  
BASKETS  
FROM 49¢ - \$1-39

EASTER COWBOY HATS  
FROM \$1-29 - 1-79

EASTER BASKETS  
(EMPTY)  
19 - 39¢

BAGGED EASTER  
39¢ GRASS

LADIES TURTLE NECK  
PULLOVERS  
\$3-99

ARTIFICIAL EASTER  
LILIES  
ONLY 29¢

LADIES SCARF &  
GLOVE SETS  
\$2-79

WOODEN HIGH  
CHAIRS  
\$17-88

LADIES PEGNOIR SETS  
S - M - L \$13-88

COME ALONG &  
SEE THE  
EASTER PARADE  
OF VALUES  
FOR ALL  
MEMBERS OF  
THE FAMILY

MENS TOE RUBBERS  
SIZES 6-11  
\$2-99

## WOOLWORTHS

MON APRIL 8<sup>TH</sup>  
9-30AM - 6PM

CLOSED FRIDAY  
APRIL 12<sup>TH</sup>

## HIGH SCHOOL BASKETBALL

The results of the basketball games held in St. John's on the weekend are as follows:-

<u>FIRST GAME</u>			
CORNER BROOK	9	LABRADOR CITY COLLEGIATE	16
<u>SECOND GAME</u>			
BISHOP'S COLLEGE	46	LABRADOR CITY COLLEGIATE	6
<u>THIRD GAME</u>			
PRINCE OF WALES	10	LABRADOR CITY COLLEGIATE	19

The two wins gave Labrador City Collegiate third place in the All Newfoundland High School Basketball Tournament.

The team and cheerleaders had a wonderful weekend in St. John's and they would like to take this opportunity to thank all the people of Labrador City and Wabush who helped in any way to make this trip possible.

---

### THE WORKMEN'S COMPENSATION BOARD

The Twelfth Annual Meeting and Safety Convention of the Newfoundland Industrial Safety Association in association with the Workmen's Compensation Board was held at Holiday Inn, St. John's, April 1st and 2nd, 1968.

The keynote speaker of the Convention was the Hon. W.J. Keough, Minister of Labour, who officially opened the two days of safety activities. Since his appointment as Minister of Labour, Mr. Keough has taken a keen interest in Industrial Accident Prevention in the Province and has been working closely with the Workmen's Compensation Board in this respect.

Other speakers at the Official Opening were Mayor Wm. Adams and Mr. Allison Dugden, Chairman of the Workmen's Compensation Board.

The Conference concluded with the Annual Banquet, when Safety Awards were presented to various industries of the Province for their achievements in accident prevention during 1967.

The theme for this year's Convention was " CANADA'S HAPPY PROVINCE - LET'S MAKE IT A SAFE ONE".

---

### BELIEVE IT OR NOT !

The Cat that made a will. Marguerite Mattignon of Paris, France a 17th century heiress had turned over a large fortune to her cat - so at the advice of her attorneys she prepared a reciprocal will which made her the pet's heiress. The cat signed the document with an inked paw.

Sir George Back of England to get help for a stranded Arctic expedition, WALKED 1,204 miles on snowshoes !

The Bronze doors of Castel Nuovo, Naples, Italy, hit by a cannon ball in 1795, still have the projectile embedded in them 473 years later.

---

PROTECTION OF EVERY DESCRIPTION  
FIRE, AUTO, SKIDOO, MARINE, LIFE, DISABILITY.

**RAY HAMMOND**

Representative for

**TOMLINSON'S INSURANCE**



CHIT CHAT

The Baptism took place last Sunday, March 31st at the United Church, Labrador City of PAULA SUZANNE CLOUTER infant daughter of Mr & Mrs Barry Clouter of Labrador City.

-----

Sorry to hear that one of our out of town readers, Mrs Carl Henry of Dalhousie, New Brunswick has been sick in hospital. Mrs Henry is the mother of Mrs. Verna Sheppard of Labrador City and all our best wishes are extended to her for a speedy recovery.

-----

Sorry to leave after a thoroughly enjoyable vacation was Jean Jones, cousin of Mrs. Harvey Gay of Labrador City. Jean spent 3½ weeks in our town, which incidently she thinks is a wonderful place and hopes to pay a return visit soon.

-----

Happy holiday to Roy and Daphne Twyne who are at present vacationing in Louisport and Windsor, Newfoundland. One thing, they are bound to improve on the weather !

-----

NOTE OF THANKS

THE COMETS COACH, MR GERRY DONAHUE WISHES TO THANK THE MANAGERS OF F.W. WOOLWORTH AND CAROL LAUNDRY FOR THEIR KIND SUPPORT OF OUR HOCKEY TEAM.

OUR DEEPEST SYMPATHY IS EXTENDED TO MR HUGHIE ROSE AND FAMILY OF VIKING CRESCENT, LABRADOR CITY, ON THE DEATH OF MR ROSE'S FATHER ON MARCH 25th, IN VICTORIA, NEWFOUNDLAND.

ENTERTAINING NIGHTLY IN  
THE LOUNGE

TOMMY BURNSIDE

SINGING COUNTRY & WESTERN AND  
POPULAR MUSIC FOR YOU

ALSO IN THE DINING ROOM SUNDAY EVENINGS

FUTURE ATTRACTION

APRIL 19<sup>TH</sup> 20<sup>TH</sup> 21<sup>ST</sup>

TICKETS ON SALE AT  
TARRANTS NEWSTAND  
LAB. CITY

NORTHERN DRUGS  
WABUSH

HOTEL FRONT DESK

THE  
GORDIE  
TAPP  
SHOW

THE  
SIR WILFRED  
GRENFELL HOTEL